

WAGNER PRESENTS

Contractor 2020

PRODUCT NAVIGATION











#UNSTOPPABLES

WAGNER

SHORT AND SIMPLY EXPLAINED

1. MATERIALS

When displaying suitable materials, we shorten these for better clarity using colour codes.















 Water and solvent-based lacquers, lacquer paints, oils, separating agents	 Synthetic resin varnishes, PVC lacquers, 2K lacquers	 Primers, fillers
 Fire protection, rust protection paints	 Emulsion and latex paints, adhesives, sealants	 Exterior paints, roof coatings, floor coatings, textured paint
 Structural waterproofing, bituminous coatings	 Filler	 Plaster

2. RECOMMENDED INTENSITY

We recommend that you select a device suited to your typical application.

 Residential	 Large residential	 Commercial
--	---	--

3. TECHNOLOGIE

Spraying method	Technologies	Drive	Other
 XVLP / HVLP	 Piston pump	 Electric	 Explosion-protection
 FineSpray	 Diaphragm pump	 Pneumatic	 TempSpray
 AirCoat	 Double diaphragm pump	 Petrol-driven	
 Airless	 Turbine		
 Plaster spraying	 Spiral pumps		

COLOUR-TESTREPORT



MACHINE & MATERIAL PERFECTLY MATCHED

The extensive WAGNER SprayGuide offers you test reports from well-known material manufacturers for use with WAGNER spray machines.

Visit sprayguide.wagner-group.com to find out how to set up your machine to match the material you are using, and which paints and lacquers can be sprayed most effectively with WAGNER technology.



More SprayGuides:
sprayguide.wagner-group.com

- ➔ Search by material type
- ➔ Search by material manufacturer
- ➔ Search by WAGNER machine and systems

Perfect surfaces and added value are our passion. Bringing colour, protection and function to surfaces is our mission. We dedicate all of our technical expertise to your objects and products, and support you with personal service. Using innovative technologies and highly efficient, reliable and user-friendly solutions, we are constantly setting new standards in surface technology.

INNOVATION SINCE 1947



Anyone purchasing a WAGNER paint spraying unit automatically receives a three-year manufacturer's warranty. But we can do more: If you register online, you can extend this warranty for a further two years, free of charge!

wagner-group.com/3plus2

FINISHCONTROL 3500 / 5000 SPRAYPACK



An all-rounder for small projects – the entry-level answer for professional coating using spray technology

- **Universally suitable:** for use with varnishes, lacquers and emulsion paints, thanks to a modular spraying attachment system for simple material changes
- **Total control:** directly on the gun
- **Extremely compact and practical**



- **Flexible:** Ideal for renovation and repair work
- **Available in two versions:** compact, hand-held unit with practical carry case or powerful with air hose

FINECOAT 9900 PLUS SPRAYPACK



High-performance HVLP paint specialist in an easy-to-use design

- **Compact and easy to use**
- **Permits precise adaptation to the object to be painted and provides an unmistakably fine spray pattern:** even with water-based materials
- **Wide range of applications:** both indoors and outdoors



- **Not suitable for:** use in potentially explosive atmospheres

The trend-setting Visco nozzle technology: produces a particularly high-quality spray pattern. This is achieved thanks to the flat jet delivered by the slot nozzle which also ensures a high working speed

High-performance turbine with a light weight: Start the turbine easily on the gun by pressing the trigger into the first level. Depress the trigger completely to start the material flow

Direct Spray Control: FinishControl is particularly easy to use. (1) The continuously adjustable air volume and the (2) material volume control ensure a precisely tailored approach to the material. (3) The spraying level and spray pattern width can be adjusted to suit the item being coated



FINISHCONTROL 5000

Click & Paint System: The paint-carrying spray attachment can be easily removed from the gun for easy cleaning. Additional spray attachments allow you to work with different materials and change colours rapidly



FINISHCONTROL 3500

Precise adjustment of the spray pattern: directly on the gun. This way the pattern can be set precisely to the particular object to be coated

In a single operation: the air flow rate and the material flow rate can be regulated directly on the gun

Ergonomic gun build: The gun fits comfortably in the hand and is effort saving. In addition, the gun is very energy efficient

Quick-release coupling with integral swivel joint: for quick connection of the gun to the air hose

Practical holder: for the gun. During breaks in work and when transporting, the gun can be safely stored on the unit

Quick cleaning of the filter: Take out the filter without tools, just briefly knock out or blow out and refit. Dirty filter warning light indicates if the filter has to be cleaned

Dual air filtration: one on the cooling side and another one on the atomizing side with an automotive type air filter with pre filter

Ultra-powerful: thanks to the 5-stage turbine

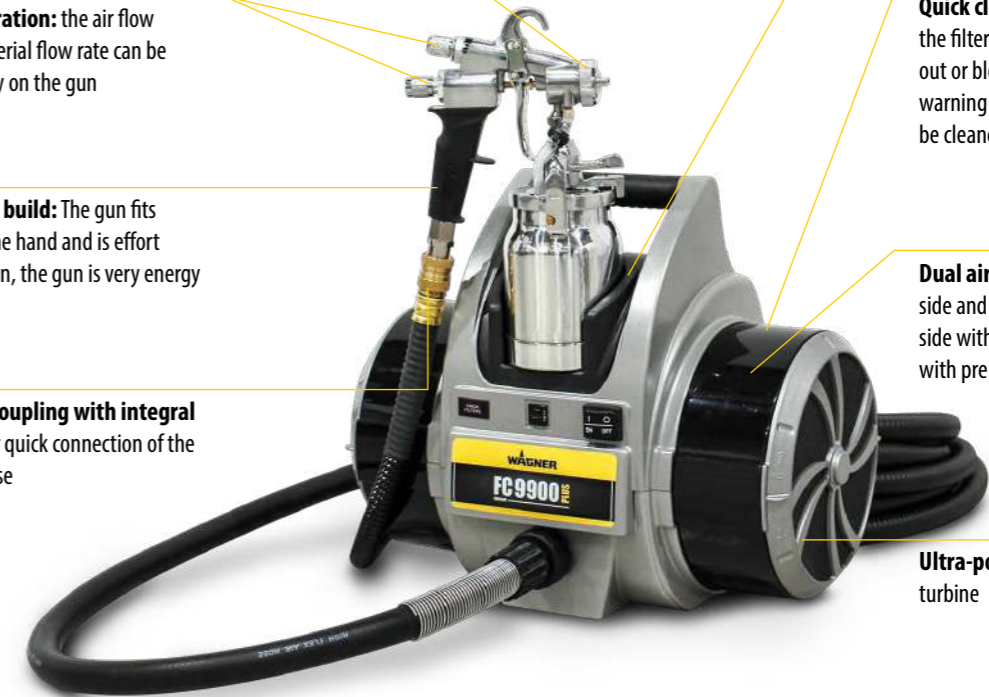

FINISHCONTROL 3500 SPRAYPACK - DPXVLP 2341501

Turbine housing with handle	-
StandardSpray spray attachment	2321879
Carrying case, for FC 3500	2341100
Air filters, 3 pieces, for FinishControl 3500	2343947
Filling hopper, 3 pieces, for FinishControl spray attachments	2324745
Carrying strap, for FC 3500	2341187
Strap holder FinishControl 3500, incl. screws	2343948
Cleaning brush	514209

FINISHCONTROL 5000 SPRAYPACK - DPXVLP 2316090

FinishControl 5000, basic unit	-
Air hose including handle, for FinishControl 5000	2314573
StandardSpray spray attachment	2321879

ACCESSORIES

FineSpray spray attachment	2321877
WallSpray spray attachment	2321880
Frontend transportation case (Tanos Systainer)	2340218
Can Adapter	2350692

FINECOAT 9900 PLUS SPRAYPACK - DPFC 276048

Air hose assy. FC 9900 Plus	277236
FineCoat gun, 1 litre pressure cup, incl. nozzle set No. 4	277035B

ACCESSORIES

FineCoat gun, 1-litre pressure cup, incl. nozzle set No. 4	279094
Gravity feed cup, for FineCoat Split Gun, 600 ml	524053
FineCoat Split Gun, suction cup, 1000 ml	524028
Nozzle set, for FineCoat, different sizes	276XXX
Nozzle set, for FineCoat Split Gun	529XXX
Air hose assy. FC-9900 Plus	277236
Hose pack, consisting of material and air hose DN10, 8.2 m	261255
Hose whip, 152 cm, for FineCoat	524405A

XVLP

High air volume – low air pressure



Are you looking for a versatile spray device that offers a wide range of applications for improvement and renovation work on small to medium-sized construction sites? Then the modular low-pressure spray systems with XVLP technology (Xtra Volume Low Pressure) from WAGNER are perfect for you – especially in terms of quality, functionality and value for money. Low-pressure spraying involves working with a large air volume and a low air pressure (up to 0.7 bar) – which results in a high working speed and minimal overspray.

Particularly powerful and flexible:

In low-pressure spraying, the atomising air generated in the turbine flows through an air hose to the paint container on the spray gun, where it then builds up pressure. This delivers the coating material through the material tube to the nozzle and atomises it with the remaining air. The spray devices of the WAGNER XVLP series offer much better atomisation performance compared to other lower-pressure devices (HVLP), thanks to a 60 percent greater air volume and 30 percent more surface coverage.

1. LESS OVERSPRAY:

The XVLP spray devices combine the positive properties of low pressure with those of a high-pressure procedure, i.e.: Less overspray and fine atomisation result in an optimised consumption of material.

2. INNOVATIVE NOZZLE TECHNOLOGY:

The combination of large air volume and innovative Visco slot nozzle technology enables a high working speed with excellent surface quality even with highly viscous paint.

Well-equipped for daily use on construction sites:

The modular system consisting of a turbine and various spray attachments enables the application of wood stains, varnishes and lacquers through to emulsions with professional quality. Thanks to the practical Click & Paint function, the attachments can be changed with a simple movement. The XVLP devices from WAGNER are perfect when starting to use spray equipment or to add to the range of devices available on site.

3. A VARIETY OF POSSIBLE USES:

The devices are especially versatile, thanks to three spray attachments – Standard-Spray, FineSpray and WallSpray – which are ideal for handling various materials.

FAR WIDER RANGE OF APPLICATIONS WITH XVLP TECHNOLOGY

Lacquers	Enamels		Emulsions
	standard	high-viscosity	
HVLP			
XVLP			

ADVANTAGES

- Easy to use
- Innovative nozzle technology
- Spray pattern adjustable to object
- Direct Spray Control: Settings are directly on the device
- Spraying of undiluted materials
- Quick material change through Click & Paint system

CONTROLPRO 350 EXTRA SPRAYPACK



The compact airless device with maximum control

- **Up to 55% less overspray:** thanks to reduced spraying pressure.
- **Direct intake from the original container:** for fast, clean painting.
- **Maximum control:** soft spray pattern makes paint application easier.



- **Valve depressor:** for high levels of operating safety and easy start-up.
- **Compact design:** make changing working location easy.
- **Available in two versions:** as compact skid version or with mobile cart.

Integrated storage box: Ideal for storing tools and accessories

High-Efficiency airless pump with reduced spraying pressure: for maximum control, a longer service life and up to 55% less overspray

Adjustable pressure control from 0 to 110 bar: for a perfect spray pattern even with differing materials

Valve depressor: for high levels of operating safety and easy start-up. The valve is released with just the press of a finger

Direct intake from the paint container: enables processing of high-viscous materials

Innovative HEA nozzle technology: two nozzle bores, one directly underneath the other, guarantee a perfect spray pattern with high material throughput even in low pressure ranges

Lightweight airless gun with two-finger trigger: for fatigue-free and safe work

Pressure gauge: Allows the perfect control of pressure in coordination with the material being processed

Also available as skid-version



HEA HIGH EFFICIENCY AIRLESS



T ≤ 0.019"; **Y** 1.5 l/min

CONTROLPRO 350 EXTRA - DPPPE

Basic unit, ControlPro 350 Extra	-
Control Pro metal gun	517101
15 m airless hose	517802
HEA reversible nozzle 311	517311
HEA reversible nozzle 515	517515
HEA reversible nozzle 619	517619
HEA filter kit	517202
Pressure gauge	0580402A
ControlPro nozzle extension, 30 cm, G-thread	517700

CONTROLPRO 350 EXTRA SKID VERSION - DPPPE 2371061

CONTROLPRO 350 EXTRA CART VERSION - DPPPE 2371065

ACCESSORIES

HEA Tip, different sizes (e.g. tip 211 - Art.No. 517211)	517XXX
Gun filter red, extra fine, 1 pc. (for HEA 211/311/313/413 nozzles)	34383
Gun filter yellow, fine, 1 pc. (for HEA 515 nozzle)	43235
Gun filter white, medium, 1 pc. (for HEA 517/619 nozzles)	34377
ControlPro nozzle extension, 30 cm, G-thread	517700
ControlPro nozzle extension, 60 cm, G-thread	517701
EasyGlide (118 ml)	508619

SUPERFINISH 23 PRO HEA SPRAYPACK



For perfect results with maximum control thanks to innovative airless diaphragm technology

- **Innovative HEA technology:** Up to 55% less overspray with maximum control.
- **Flexible suction hose:** The diaphragm pump draws materials such as emulsions, latex paints or lacquers directly from the original container.
- **For small emulsion jobs**
- **Easy to move:** The SuperFinish 23 Pro, with its foldable



- frame, is ideal for easy and space-saving transport on the construction site.
- **SuperFinish 23 Pro is virtually maintenance-free:** works reliably and durably and can be used with even small amounts of material.

Superb Spray Surface Quality: with the Vector Pro Airless gun. Light in weight with a long service life

Flexible Suction Hose for direct suction from the container: Trouble free working thanks to the special fine mesh suction intake filter

HEA Pressure Gauge: allows monitoring of the spray device pressure. HEA nozzles allow work in the low-pressure range (ideally at 80 - 140 bar) that is marked with green on the pressure gauge

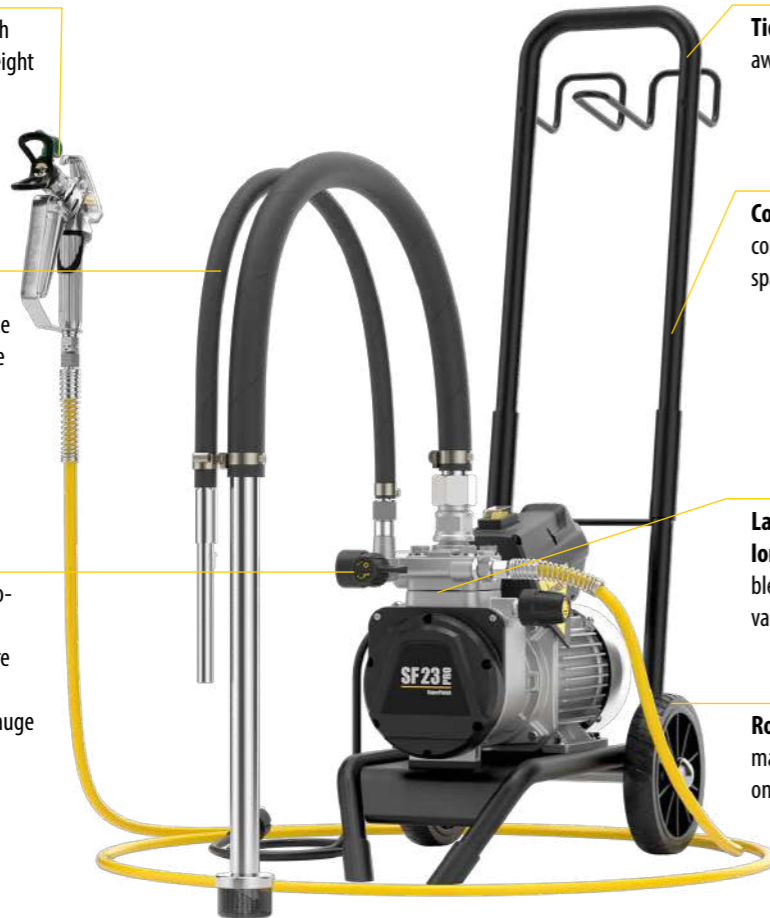

Tidy: Hoses can be practically stowed away thanks to the integrated rack

Convenience: The foldable frame allows convenient building site transport and space saving storage

Large variety of materials with QLS long-stroke technology: Made possible by optimised hydraulics and special valve technology

Robust design: with heavy duty tyres making the SF 23 Pro the perfect partner on every construction site

HEA HIGH EFFICIENCY AIRLESS

≤ 0.023"; 2.6 l/min

SUPERFINISH 23 PRO HEA SPRAYPACK - DPFSF 2399198

Basic unit, SF 23 Pro, cart version	-
HP hose DN6, 25 MPa, NPSM 1/4", 15m	2390608
Suction hose assy. (return hose and filter included)	2393123
Airless Vector Pro gun, 1/4", incl. TradeTip 3 nozzle holder, with 4-finger trigger	538040
HEA ProTip, 519	554519
HEA pressure gauge set assy	252475
Tool bag, incl. wrench 41mm/22mm/19mm and screw driver	2390620

ACCESSORIES

HEA ProTip, different sizes (e.g. tip 211 - Art.No. 517211)	554XXX
5 litre hopper, M36x2	341265
Nozzle extension, 30 cm, G-thread	556075
Nozzle extension, 60 cm, G-thread	556077
Hydraulic oil Divinol 1 litre	21061
TipClean; 200ml	2400214

PRACTICAL ACCESSORIES SF 23 PRO

AIRLESS GUNS

Vector Pro, 1/4", incl. TradeTip 3 nozzle holder, with 2-finger trigger	538041
Vector Pro, 1/4", incl. TradeTip 3 nozzle holder, with 4-finger trigger	538040
Vector Grip, 1/4", incl. TradeTip 3 nozzle holder, with 2- and 4-finger trigger	538043

AIRLESS HOSE

HP hose DN3, max. 27 MPa, NPS 1/4", 7.5 m	9984583
---	---------

AIRCOAT ACCESSORIES

AirCoat gun AC 4500, incl. blue air cap and holder	2368269
HP double hose, material DN3, max. 27 MPa, air DN6, 1/4", 7.5 m	9984564
AirCoat regulator, fitting kit	340250

OTHERS

5 litre hopper, M36x2	341265
Pressure gauge set assy. HEA(MPa)	2383995
Nozzles HEA ProTip, different sizes	554XXX
Nozzles TradeTip 3, different sizes	553XXX

RECOMMENDED USE

MATERIALS:

Water and solvent-based lacquers, lacquer paints, oils, separating agents	Synthetic resin lacquers, PVC lacquers, 2K lacquers
Primers, fillers	Fire protection, rust protection paints
Emulsion and latex paints, adhesives, sealants	Exterior paints, roof coatings, floor coatings, textured paint

OBJECT SIZE:



TECHNICAL DATA

Motor output	1.3 kW
Voltage	230 V / 50 Hz
Max. operating pressure	250 bar, 25 MPa
Max. delivery rate	2.6 l/min
Weight	27 kg
Max. nozzle size	0.023"
Max. viscosity	20.000 mPas





HEA - HIGH EFFICIENCY AIRLESS

up to 55% less overspray with maximum control

Do you already value the advantages of airless technology, such as control and comfort? Then you'll be inspired by the new HEA ProTip airless nozzle from WAGNER. It achieves perfect surface results at a much lower spray pressure. Compared to conventional airless technology, the spray edges are softer, the result more even and free from streaks on the edges.

More efficiency for prolonged working:

Thanks to the HEA nozzle technology, the spray pressure can be significantly lowered. This reduces the overspray by up to 55 percent. Apart from the much lower masking effort required, this also has a positive effect on the gun's recoil. Working with a WAGNER airless pump is made even easier and more convenient with the HEA technology.

1. MAXIMUM CONTROL:

The gentle spray pattern ensures a more even surface when overlapping the paths and avoids hard edges. This leads to a simple and easy-to-learn technique – even for inexperienced users.

2. PERFECT SURFACE QUALITY:

High Efficiency Airless ensures a uniform and even application on all surfaces and therefore offers excellent surface quality – especially when compared to conventional applications with a brush and roller.

Robust and durable:

The nozzle wears more slowly due to the lower spray pressure. This means that HEA nozzles can be used for considerably longer than conventional airless nozzles. Loads on the pump are also reduced due to the lower pressure, with handling of the gun also improved.

3. INCREASED EQUIPMENT LIFESPAN:

Even the lifespan of the spray device itself is prolonged: the lower spraying pressure with High Efficiency Airless means that the system and its components are under less strain.



SUPERFINISH 23 PLUS HEA SPRAYPACK



Compact – light and yet robust

- **Innovative, low-pressure airless technology:** up to 55% less overspray
- **Compact:** Smallest in its class, mobile and light
- **For medium-sized emulsion jobs**
- **Robust:** Ideal for demanding construction site use
- **PumpRunner:** Perfect for clean, tidy transport



- Use with 20 m hoses guaranteed with any material

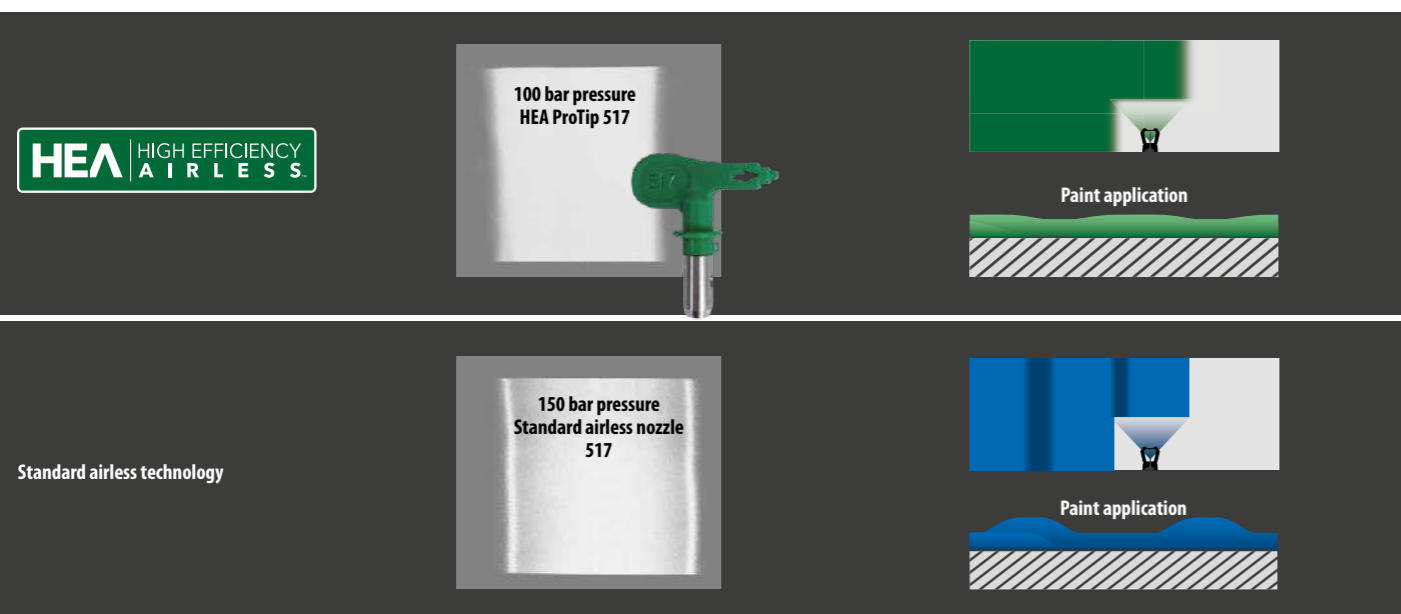

*Compared to other airless nozzles on the market

Large variety of materials with QLS long-stroke technology: The optimised hydraulics and special valve technology make it possible

Multifunction switch for extra safety: on/off as well as circulation and spray mode. This prevents accidental switching on or off while the system is under pressure



Superb Spray Surface Quality: with the Vector Grip Airless gun. Light in weight with a long service life

Infinitely variable pressure regulation: from 0 to 250 bar

Direct suction: straight from the container for trouble-free working. Inclusive PumpRunner for clean transport included

T ≤ 0.023"; **W** 2.6 l/min

SUPERFINISH 23 PLUS HEA SPRAYPACK - DPFSF 2384153

Basic unit, SF 23 Plus, cart version	-
Suction system complete, for SF 23 Plus, incl. PumpRunner	2342879
HP hose DN6, 27 MPa, NPSM 1/4", 15 m	9984574
Pressure gauge set assy. HEA (MPa)	2383995
Airless gun Vector Grip, 1/4", incl. TradeTip 3 nozzle holder, with 2- and 4-finger trigger	538043
HEA ProTip 519	554519

ACCESSORIES

HEA ProTip, different sizes (e.g. tip 211 - Art.No. 517211)	554XXX
5 litre hopper, M36x2	341265
Nozzle extension, 30 cm, G-thread	556075
Nozzle extension, 60 cm, G-thread	556077
Hydraulic oil Divinol 1 litre	21061
TipClean; 200ml	2400214

SUPERFINISH 23 PLUS TEMPSPRAY SPRAYPACK



Enamel specialist with heated hose

- **Perfect surface results:** thanks to heated hose
- **Also ideal for:** highly viscous materials such as enamels with high VOC content
- **The TempSpray system heats the material directly in the hose:** thereby ensuring perfect viscosity without the need for thinning, as well as optimum paint application



Perfect surface quality with Temp-Spray: Thanks to warming up the coating material a very soft spray pattern is generated. This increases the atomisation quality. Further advantages are: reduced overspray, perfect viscosity without diluting and much more

Large variety of materials with QLS long-stroke technology: The optimised hydraulics and special valve technology make it possible

Superb Spray Surface Quality: with the Vector Grip Airless gun. Light in weight with a long service life

Infinitely variable pressure regulation: from 0 to 250 bar

Multifunction switch for extra safety: on/off as well as circulation and spray mode. This prevents accidental switching on or off while the system is under pressure

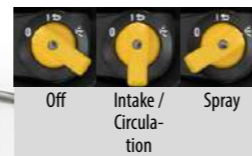

≤ 0.023"; 2.6 l/min

SUPERFINISH 23 PLUS TEMPSPRAY SPRAYPACK - DPFSF 2341496

Basic unit, SF 23 Plus on cart	-
5 litre hopper, M36x2	341265
TempSpray H 126 basic unit, 10 m	2311659
Airless gun Vector Grip, 1/4", incl. TradeTip 3 nozzle holder, with 2- and 4-finger trigger	538043
2SpeedTip, L10, 208 / 510	271042
Gun filter red, 1 piece, 180 MA, 0.084 mm MW, extra fine	34383

ACCESSORIES

TradeTip 3 FineFinish nozzles, different sizes (e.g. tip 210 - Art. No. 517210)	554XXX
2SpeedTip, different sizes	271XXX
5 litre hopper, M36x2	341265
Nozzle extension, 30 cm, G-thread	556075
Nozzle extension, 60 cm, G-thread	556077
Hydraulic oil Divinol 1 litre	21061
TipClean; 200ml	2400214

SUPERFINISH 23 PLUS AIRLESS ENAMEL SPRAYPACK



The perfect solution for small paint jobs using diaphragm technology

- **Entry-level Airless spraypack**
- **Straightforward handling and simple operation:** Multifunction switch for greater safety - It is impossible to turn the unit on and off under pressure
- **Improved performance:** No-maintenance brushless motor



- **FineFinish painting:** with hopper and the special FineFinish nozzle

Large variety of materials with QLS long-stroke technology: The optimised hydraulics and special valve technology make it possible

Superb Spray Surface Quality: with the Vector Grip Airless gun. Light in weight with a long service life

Infinitely variable pressure regulation: from 0 to 250 bar

Multifunction switch for extra safety: on/off as well as circulation and spray mode. This prevents accidental switching on or off while the system is under pressure



≤ 0.023"; 2.6 l/min

SUPERFINISH 23 PLUS AIRLESS ENAMEL - CART VERSION DPFSF 2341492

Basic unit, SF 23 Plus on cart	-
5 litre hopper, M36x2	341265
HP hose DN3, 27 MPa, NPS 1/4", 7.5 m	9984583
Airless gun Vector Grip, 1/4", incl. TradeTip 3 nozzle holder, with 2-finger trigger	538042
2SpeedTip, L10, 208 / 510	271042
Gun filter red, 1 piece, 180 MA, 0.084 mm MW, extra fine	34383

ACCESSORIES

TradeTip 3 FineFinish nozzles, different sizes (e.g. tip 210 - Art. No. 517210)	554XXX
2SpeedTip, different sizes	271XXX
5 litre hopper, M36x2	341265
Nozzle extension, 30 cm, G-thread	556075
Nozzle extension, 60 cm, G-thread	556077
Hydraulic oil Divinol 1 litre	21061
TipClean; 200ml	2400214

SUPERFINISH 23 PLUS AIRCOAT ENAMEL SPRAYPACK



Mobile complete solution for enamel work

- **With AirCoat technology:** Particularly fine atomisation for a perfect finish
- **Perfectly matching components:** Minimal overspray and high application efficiency
- **Particularly easy handling**
- **The industry standard:** quality-crafted by WAGNER



- **Suitable for:** non EX environments

COBRA 40-10 AIRCOAT SPRAYPACK



The best-selling unit in the AirCoat range – to satisfy the most demanding coating needs

- **Flexible:** Very small volume processing with hopper or work directly from the original container
- **When used with hopper:** Frequent colour changes are no problem thanks to the unit's easy-to-clean design
- **Unique double diaphragm technology:** Perfect for materials sensitive to shearing and moisture as well as for premixed 2K materials



- **Suitable for use in potentially explosive atmospheres**

Large variety of materials with QLS long-stroke technology: The optimised hydraulics and special valve technology make it possible

Also available with AirBoost 100 compressor (art. no. 2353393)

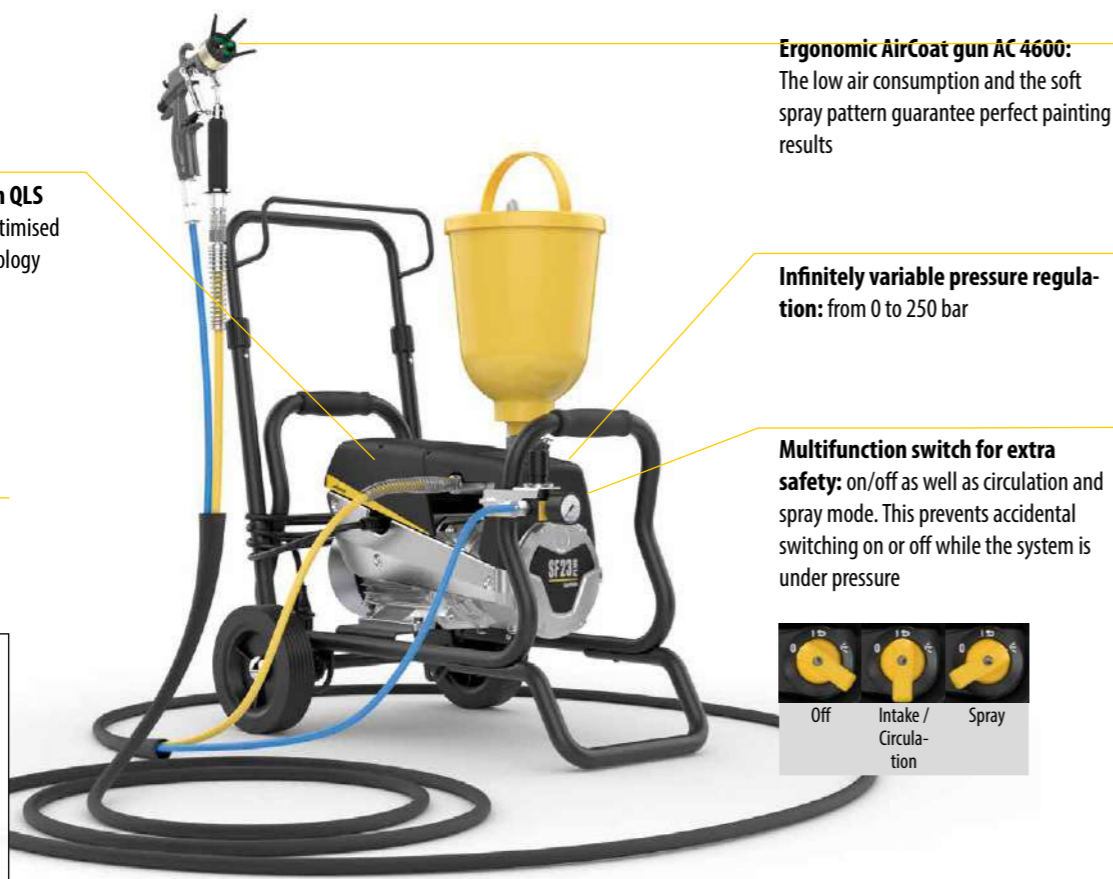

Ergonomic AirCoat gun AC 4600: The low air consumption and the soft spray pattern guarantee perfect painting results

Infinitely variable pressure regulation: from 0 to 250 bar

Multifunction switch for extra safety: on/off as well as circulation and spray mode. This prevents accidental switching on or off while the system is under pressure

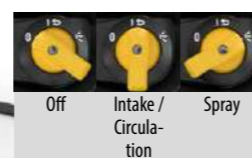

T ≤ 0.023"; **W** 2.6 l/min

SUPERFINISH 23 PLUS AIRCOAT ENAMEL SPRAYPACK - DPFSF 2341490

Basic unit, SF 23 Plus on cart	-
5 litre hopper, M36x2	341265
HP double hose, material DN3, max. 27 MPa, air DN6, 1/4", 7.5 m	9984595
AirCoat gun AC 4600 Professional, incl. blue air cap and holder	394156
Nozzle ACF3000 11/40	379411
AirCoat regulator, fitting kit	340250

ACCESSORIES

Compressor AirBoost 100	2347935
AirCoat nozzle ACF 3000, different sizes	379XXX
Blue air cap, incl. union nut	394911
Green air cap, incl. union nut	394912
Red air cap, incl. union nut	394910
Union nut complete	394921
Gun filter, yellow, fine, set of 10 pieces,	97023
Gun filter, red, extra fine, set of 10 pieces	97022



To adapt optimally to different materials, there is a choice of three air caps: blue (for water-based materials), red (for solvent-based materials) and green (for water-based and solvent-based materials. Their low air consumption saves energy and costs)

No tools: needed to open the filter housing for cleaning or to replace the filter

Precise: adjustment of air flow thanks to the integrated AirCoat regulator. The pressure levels can be checked at any time on the pressure gauge

High-quality AirCoat gun: Continuous adjustment of air and pattern width, smooth air and material joints, no tools required to clean or replace the filter

Ideally suited for the application of small quantities: Thanks to the ease of cleaning, fast colour changes are possible at any time

Very easy handling: Thanks to its small cross-section of 3 mm, the flexible double hose contains just a small amount of material, making it easy to fill and quick to clean.

Light weight: The low weight of 23 kg and the stable metal frame make the Cobra 40-10 compact and practical

T ≤ 0.023"; **W** 2 l/min

COBRA 40-10 AIRCOAT SPRAYPACK - ILGR 322112

Basic unit, Cobra 40-10, skid version	-
HP double hose, material DN3, max. 27 MPa, air DN6, 1/4", 7.5 m	9984595
AirCoat gun AC 4600 Professional, incl. red air cap and holder	394157
Nozzle ACF3000 11/40	379411
AirCoat regulator assy.	2333479
5 litre hopper EX	2344505

ACCESSORIES

AirCoat nozzle ACF 3000, different sizes	379XXX
Blue air cap, incl. union nut	394911
Green air cap, incl. union nut	394912
Red air cap, incl. union nut	394910
Union nut complete	394921
Gun filter, yellow, fine, set of 10 pieces,	97023
Gun filter, red, extra fine, set of 10 pieces	97022



SUPERFINISH 23 INJECTION SPRAYPACK



Professional crack repair

- **Powerful:** big diaphragm surface for perfect usage with high viscosity materials and a long life time
- **Variety of materials:** suitable for Epoxy and Polyurethanes (PU), SPUR foam, aqueous solutions
- **Simple:** service, cleaning and maintenance directly on the job site is no problem at all



- **Ease of use:** handy pressure regulation in low pressure areas (starting from 10 bar)

Easy to clean: 5 litre hopper for quick material changeovers and small quantities processing

Precise injection: Easy to use with all packings commercially available

Pressure relief valve directly on the device: Return ball valve specifically for injection applications

Optimum cooling: Low-temperature pump head, cools the device in operation

Easy transport: Stable cart with pole adjustable in height

Inlet pusher valve: for a high operating reliability and easy commissioning. Just the press of a finger, and the valve is free

Brushless motor: Maintenance-free and total reliability

Ease of use: Infinitely variable pressure regulation from 0 to 250 bar



ACCESSORIES

Airless Vector Pro gun; 1/4"; incl. TradeTip 3 nozzle holder; with 4-finger trigger	538040
HP hose DN6, 27 MPa, NPSM 1/4", 15 m	9984574
Hose whip with mouthpiece	97057
Seal, for nozzle installation	43052
5 litre hopper, M36x2	341265
InlineRoller packaged in a plastic box, incl. HP hose DN4, 27 MPa, 7.5 m, extension complete 0.5 m, woven plush paint roller short pile 13 mm, and so on	345010

2.6l/min

SUPERFINISH 23INJEKTION - DPFSF **2361599**

Basic unit, SF 23i on cart	-
Complete hopper, for injection	2357506
Pressure gauge combination 250 - 400 bar, I = 1/4", A = 1/4"	340256

DIAPHRAGM PUMP

Effective material intake – broad range of materials

Do you want to process different materials, from primers to silicate paints with just one device? Then a WAGNER diaphragm pump is the ideal choice. This powerful, maintenance-friendly technology transports the material via a lifting motion of the diaphragm. Diaphragm pumps from WAGNER are robust, easy-to-use construction site and workshop units.

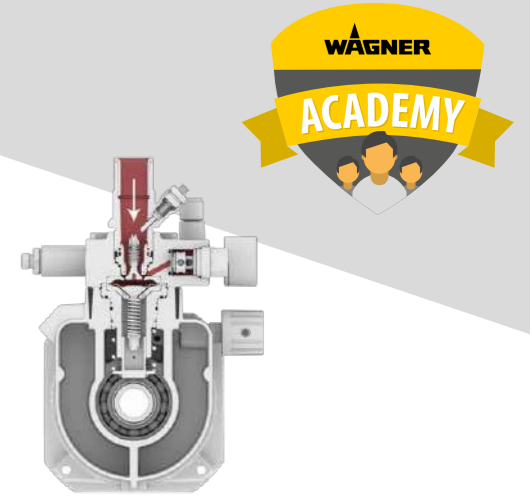

The perfect companion for painters and affiliated trades:

The patented Quality-Long-Stroke (QLS) technology from WAGNER, with its optimised hydraulics and special valve technology, means that the material is taken in much more effectively compared to diaphragm pumps from other manufacturers. As a result, a broad range of different materials, such as primers and release agents, primers and lacquers, emulsion and silicate paints, fabric adhesives, corrosion and flame retardants can be processed. In the domain of specially filled materials such as bitumen, fire protection and fillers, piston and spiral pumps are the specialists. Electrically operated diaphragm pumps can be used in both Airless and AirCoat processes with additional air atomization.

1. ALSO SUITABLE FOR VERY SMALL VOLUMES:

Diaphragm pumps have up to 58 per cent* less material in their system. The device's small cross-sections means that it can also be operated with tiny amounts of material. This saves resources both when changing material and during the cleaning process.

2. LOW-MAINTENANCE AND DURABLE:

The reduced lifting frequency of the diaphragm means that the already lower number of wear parts are placed under significantly less stress. This significantly reduces maintenance costs*. However, should a repair be necessary, the corresponding components can be easily replaced directly on site and in the case of both valves for example, within minutes.

Fire retardants for joiners, metalworkers and similar trades :

Pneumatic double diaphragm pumps are ideal for the wood and metal processing industry. In this case, the material is transported via the lifting motion of two opposing diaphragm which generates a lower-pulsation material flow. This allows you to work with materials which are particularly sensitive to shearing and moisture and with premixed two-component materials. WAGNER double diaphragm pumps are explosion-proof and operated by compressed air, which means that they can be used safely in workshops and in painting booths.

3. FINE AND EVEN SPRAY PATTERN:

Diaphragm technology reduces the pulsation of the material flow, which avoids any irregularities in the spray pattern. It remains fine and even. The piston's switching point is also dispensed with in a diaphragm pump.

SPRAYPATTERN AT LOW PRESSURE



irregular spray pattern from the piston pump



even spray pattern from the diaphragm pump

BENEFITS

- Large range of material
- Flexible material intake
- Fully adjustable pressure regulation from 0 - 25 MPa
- QLS technology with longer stroke
- Low-pulsation
- Robust and very low-maintenance
- Simple maintenance
- Low noise

*Compared to other piston pumps on the market

SUPERFINISH 33 PLUS SPRAYPACK



The extremely easy-to-use diaphragm pump for every project

- **Versatile applications:** The SuperFinish 33 Plus can process a diverse range of materials and service a wide variety of industries and project sizes.
- **Optimum efficiency and productivity:** With a delivery rate of 4.3 litres per minute, the SuperFinish 33 Plus is the most powerful WAGNER diaphragm pump in the professional segment.



- **Practical multi-gun operation:** For parallel use, a distributor adapter for connecting up to three airless guns is available separately as an accessory.
- **Flexible use:** Switch the pump position with a single hand movement from working with the top container to the rigid suction system with fine filter meshes.

Ergonomic working: with the high quality Vector Grip Airless gun. It is light, robust and highly ergonomic

Modular variants: two-position cart for use with the top container or rigid suction system



Includes a handy 230 V socket : to connect additional devices, such as TempSpray

Inlet pusher valve: for a high operating reliability and easy commissioning. Just the press of a finger, and the valve is free

Illuminated multifunction switch for extra safety: on/off as well as circulation and spray mode. This prevents accidental switching on or off while the system is under pressure

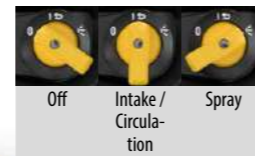

Direct suction: straight from the container for trouble-free working – thanks to the special filter with ultra-fine filter mesh

Integrated toolbox: including a handy organiser to ensure the right tools and accessories are always at hand



Robust, building-site-friendly tires: allow easy transport across even the most challenging terrain

NEW

≤ 0.033"; 4.2 l/min

SUPERFINISH 33 PLUS SPRAYPACK - DPFSF 2388259

SuperFinish 33 Plus, basic unit	-
Suction system, rigid, D38	2370310
HP hose DN6, max. 27 MPa, NPSM 1/4", 15 m	9984574
Airless gun Vector Grip, 1/4", incl. TradeTip 3 nozzle holder, with 2- and 4-finger trigger	0538043
2SpeedTip nozzle D20 115/421	0271046

ACCESSORIES

TradeTip 3 FineFinish nozzles, different sizes (e.g. tip 211 - Art. No. 517211)	554XXX
TradeTip 3 FineFinish nozzles, different sizes	554XXX
Nozzles TradeTip 3, different sizes	553XXX
Nozzles 2SpeedTip, different sizes	271XXX
5 litre hopper, M36x2	341265
Nozzle extension, 30 cm, G-thread	556075
Nozzle extension, 60 cm, G-thread	556077
Hydraulic oil Divinol 1 litre	21061

HANDY ACCESSORIES SF 33 PLUS

AIRLESS GUNS

Vector Pro, 1/4", incl. TradeTip 3 nozzle holder, with 4-finger trigger	538040
Vector Pro, 1/4", incl. TradeTip 3 nozzle holder, with 2-finger trigger	538041
Vector Grip, 1/4", incl. TradeTip 3 nozzle holder, with 2- and 4-finger trigger	538043
Vector Infinity, G-thread 1/4", incl. TradeTip 3 nozzle holder, with 2-finger trigger	538085
AG 14, G-thread 1/4", incl. TradeTip 3 nozzle holder	0502081A

AIRLESS HOSES

HP hose DN3, max. 27 MPa, NPS 1/4", 7,5 m	9984583
HP hose DN6, max. 27 MPa, NPS 1/4", 15 m	9984574
HP hose DN6, max. 27 MPa, NPS 1/4", 30 m	9984575
HP hose DN10, max. 25 MPa, 3/8" NPSM, 15 m	2336583

AIRLESS NOZZLES

2SpeedTip nozzles, different sizes	271XXX
TradeTip 3 nozzles, different sizes	553XXX
HEA ProTip nozzles, different sizes	554XXX

GUN FILTERS

Gun filter red, 10 pieces, 180 MA, 0.084 mm MW, extra fine	97023
Gun filter yellow, 10 pieces, 100 MA, 0.14 mm MW, fine	97022
Gun filter white, 10 pieces, 50 MA, 0.31 mm MW, medium	97024

AIRCOAT ACCESSORIES

AirCoat gun AC 4500, incl. blue air cap and holder	2368269
HP double hose, material DN3, max. 27 MPa, air DN6, 1/4", 7.5 m	9984595
AirCoat regulator, fitting kit	340250
AirCoat nozzles ACF3000 (different sizes)	379XXX

OTHER

InlineRoller packaged in a plastic box, incl. HP hose DN4, 27 MPa, 7.5 m, extension complete 0.5 m, woven plush paint roller short pile 13 mm, and so on	345010
Adapter for multi-gun operation (up to 3 guns)	2304430
Double connector A = 1/4" x 1/4"	34038
Coupling sleeve I = 1/4" NPSM x A = 3/8" NPSM, 27 MPa	179732
Hopper set, 5 litre, M36x2	341265
PumpRunner	2306987
Nozzle extension, 15 cm, G-thread	556074
Hose reel HR30, M16x1.5	2392523

RECOMMENDED USE

MATERIALS:

Water and solvent-based lacquers, lacquer paints, oils, separating agents	Synthetic resin lacquers, PVC lacquers, 2K lacquers
Primers, fillers	Fire protection, rust protection paints
Emulsion and latex paints, adhesives, sealants	Exterior paints, roof coatings, floor coatings

OBJECT SIZE:



For different project sizes

TECHNICAL DATA

Motor output	2.2 kW
Voltage	230 V / 50 Hz
Max. operating pressure	250 bar, 25 MPa
Max. delivery rate	4.3 l/min
Delivery rate at 12 MPa spray pressure	3.8 l/min
Max. nozzle size	0.033"
Weight	50 kg

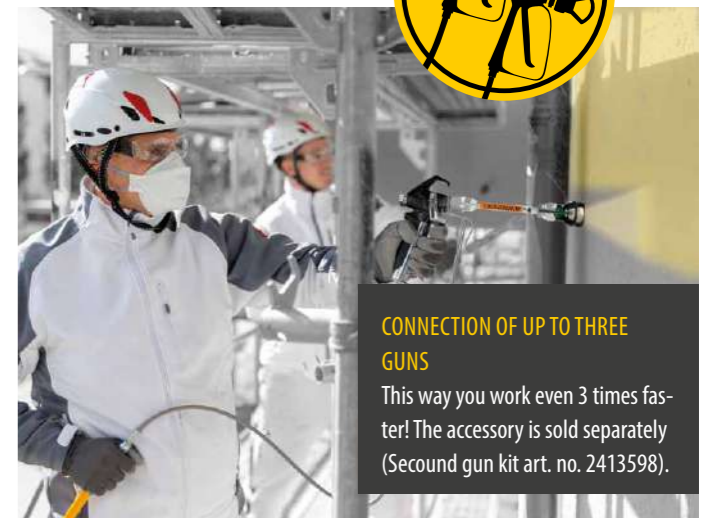

CONNECTION OF UP TO THREE GUNS

This way you work even 3 times faster! The accessory is sold separately (Secound gun kit art. no. 2413598).

SUPERFINISH 33 PRO SPRAYPACK



One diaphragm pump for every project – outstanding performance for indoor and outdoor application

- **Versatile applications:** The SuperFinish 33 Pro can process a diverse range of materials and service a wide variety of industries and project sizes.
- **Optimum efficiency and productivity:** With a delivery rate of 4.3 litres per minute, the SuperFinish 33 Pro is the most powerful WAGNER diaphragm pump in the professional segment.



- **Quality LongStroke Technology (QLS):** For a long service life, easy maintenance and low wear.
- **Practical multi-gun operation:** For parallel use, a distributor adapter for connecting up to three airless guns is available separately as an accessory.

Ergonomic work: With the Airless gun Vector Pro. It is light and robust

Easy to transport: Robust cart with height-adjustable handle

Inlet pusher valve: for a high operating reliability and easy commissioning. Just the press of a finger, and the valve is free

Large variety of materials with QLS long-stroke technology: The optimised hydraulics and special valve technology make it possible



Robust, building-site-friendly tires: allow easy transport across even the most challenging terrain

T ≤ 0.033"; **W** 4.2 l/min

SUPERFINISH 33 PRO SPRAYPACK - DPFSF 2388 260

SuperFinish 33 Pro, basic unit	-
Suction system, flexible	34630
HP hose, DN6, PN270, NPSM 1/4", 15m	9984574
Airless gun Vector Pro, 1/4", incl. TradeTip 3 nozzle holder, with 4-finger trigger	0538040
TradeTip3 nozzle 523 incl. white filter	553523

ACCESSORIES

TradeTip 3 FineFinish nozzles, different sizes (e.g. tip 211 - Art. No. 517211)	554XXX
TradeTip 3 FineFinish nozzles, different sizes	554XXX
Nozzles TradeTip 3, different sizes	553XXX
Nozzles 2SpeedTip, different sizes	271XXX
5 litre hopper, M36x2	341265
Nozzle extension, 30 cm, G-thread	556075
Nozzle extension, 60 cm, G-thread	556077
Hydraulic oil Divinol 1 litre	21061
TipClean; 200ml	2400214

PISTON PUMP

Especially high suction and delivery performance – across the range



Do you mostly work with high-viscosity or filler materials? Then a WAGNER piston pump is the perfect, reliable site companion for you. The high suction power produced by the piston's lifting motion makes it ideal for this type of material.

Various performance classes for professional and semi-professional users: With the third generation of piston pumps from WAGNER, you have a choice of machines for large or small sites. They cover a broad range of paints and emulsions - right through to high-viscosity and filler materials for interior and exterior use.

A powerful companion - inside and out:

WAGNER piston pumps are available with three different drive systems. Electric piston pumps cover a wide range of performance classes and have a compact design. The hydraulic piston pumps offer even better performance and are available with a choice of either petrol or electric motors which can be switched in a few minutes. Pneumatically driven piston pumps from WAGNER are explosion-proof and therefore are suitable for use in workshops.

1. WITH EVEN MORE POWER ON THE CONSTRUCTION SITE:

The patented SSP (Special Spray Power) system from WAGNER is a technology that is unique on the market for the application of high viscosity materials. The special design of the system ensures that the pump is continually filled with sufficient material by the shovel piston. SSP is available for all HeavyCoat models.

2. NO CONTINUOUS RUNNING:

Piston pumps only operate when you have to build up pressure. The rest of the time, the drive is on 'standby'. This protects wear parts and has a positive impact on site noise levels.

CROSS-SECTION OF THE PISTON



Hydraulic piston pump



Additional power "Special-SprayPower" for high viscosity materials

ADVANTAGES

- Powerful suction
- Better delivery capacity with high viscosity materials
- Less sensitive to heavily filled materials
- High material pressure / material volume allow long hose lengths
- Large nozzle sizes can be used
- Extra-durable Packing

POWERPAINTER 90 EXTRA SPRAYPACK



Fast, clean, perfect – the airless paint spraying system for small projects

- **Innovative, high-efficiency airless technology (HEA):** The HEA ProTip nozzle ensures up to 55% less overspray, as well as a longer service life thanks to reduced spray pressure.
- **Easy painting:** Noticeably easier paint application thanks to a soft spraying pattern with maximum control.
- **Direct suction from the original container:** The



airless paint spraying system extracts materials directly out of the paint bucket or varnish container.

Comfortable: The variably adjustable telescopic handle allows a convenient transport on the construction site and a space-saving storage of the device

Pressure gauge: Allows the perfect control of pressure in coordination with the material being processed

DIN 6, 15 m high-pressure hose: for a large radius of action.

Integrated storage box: Ideal for storing tools and accessories



HEA HIGH EFFICIENCY AIRLESS

Innovative HEA nozzle technology: two nozzle bores, one directly in front of the other, guarantee a perfect spray pattern with high material throughput even in low pressure ranges

Lightweight airless gun with four-finger trigger: for fatigue-free and safe work

Inlet pusher valve: for a high operating reliability and easy commissioning. Just the press of a finger, and the valve is free

≤ 0.019" ; 1.6 l/min

POWERPAINTER 90 EXTRA SPRAYPACK - DPPPE 2401275

Basic unit, PowerPainter 90 Extra	-
Airless gun Vector Pro, 1/4", incl. TradeTip 3 nozzle holder, with 4-finger trigger	538040
HP hose DN6, 15 m	523699
Pressure gauge (HEA)	2383995
HEA ProTip 517	554517
EasyGlide, special oil, 118 ml	508619

ACCESSORIES

Airless Vector Grip gun, 1/4", incl. TradeTip 3 nozzle holder, with 2- and 4-finger trigger	538043
TradeTip 3 FineFinish nozzles, different sizes	554XXX
Nozzle extension, 15 cm, G-thread	556074
Nozzle extension, 30 cm, G-thread	556075
EasyGlide, special oil, 118 ml	508619
TipClean; 200ml	2400214

NOTES

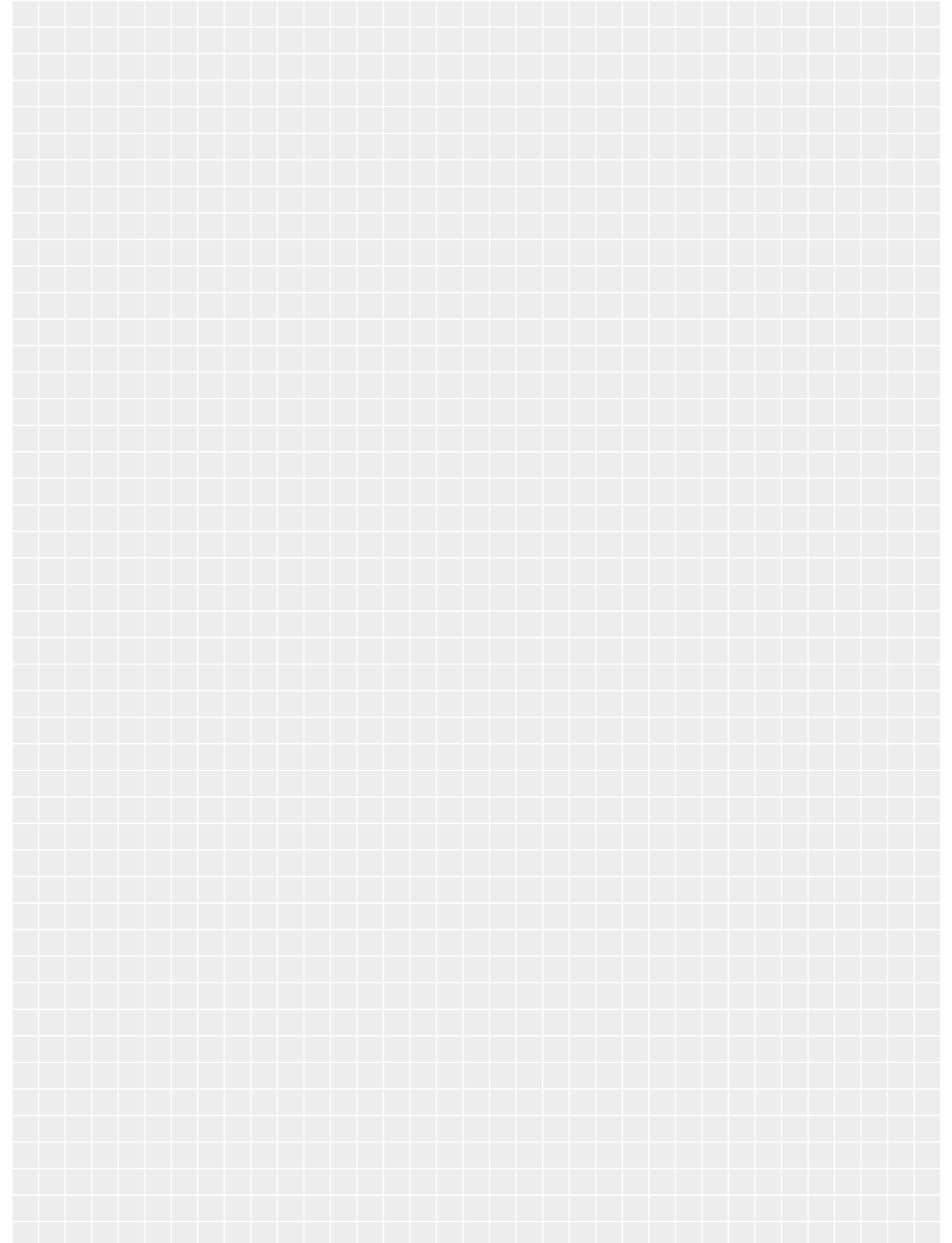

PROSPRAY 20 HEA SPRAYPACK



The robust piston pump for Airless beginners

- **Built tough:** for a long service life on the construction site
- **Compact and simple design**
- **Easy handling:** thanks to HEA technology
- **Optimised lifetime and performance**



- **Innovative ProSpray product features:** for example new packings

PROSPRAY 3.21 HEA SPRAYPACK



Small and compact – for small object sizes

- **Innovative, low-pressure airless technology:** up to 55% less overspray
- **Optimum value-for-money:** Ideal for all users who mostly spray-coat small surfaces on a daily basis
- **For trouble-free operation:** Integrated high-pressure filter



- **Compact design with outstanding performance data:** 0.023" nozzle size, 2.0 l/min max., delivery rate: 16 kg weight
- **With flexible suction system:** for simple intake directly from the original container

Compact: for easy transportation and space-saving storage

HEA Pressure Gauge: longer life thanks to innovative HEA low-pressure airless technology

Practical cable wrap: for tidy storage of the electric cable

HEA 517 nozzle: soft spray pattern and up to 55% less overspray

DN6, 15 m high-pressure hose: for a large radius of action

Drip cup: possible residues in the suction hose can be captured during transport

NEW



HEA HIGH EFFICIENCY AIRLESS

Compact: for easy transportation and space-saving storage

Maintenance made easy: With the push of a button the piston is oiled and thus the packings are conserved.

HEA Pressure Gauge: longer life thanks to innovative HEA low-pressure airless technology

HEA 517 Tip: soft spray pattern and up to 55% less overspray

DN6, 15 m high-pressure hose: for a large radius of action

Inlet pusher valve: for a high operating reliability and easy commissioning. Just the press of a finger, and the valve is free.



HEA HIGH EFFICIENCY AIRLESS

T ≤ 0.021"; **Y** 1.6 l/min

PROSPRAY 20 HEA SPRAYPACK - DPPS 2403616

ProSpray 20, basic unit	-
HP hose DN6, 27 MPa, NPSM 1/4", 15 m	9984574
Flexible suction system	0558672A
Pressure gauge set assy. HEA(MPa)	2383995
Airless Vector Pro gun, 1/4", incl. TradeTip 3 nozzle holder, with 4-finger trigger	538040
HEA ProTip 517	554517

ACCESSORIES

HEA ProTip, different sizes (e.g. tip 211 - Art.No. 517211)	554XXX
TradeTip 3 FineFinish nozzles, different sizes	554XXX
5 litre hopper	704-453
HP hose DN4, 27 MPa, NPS 1/4", 7.5 m	9984573
Nozzle extension, 15 cm, G-thread	556074

T ≤ 0.023"; **Y** 2 l/min

PROSPRAY 3.21 HEA SPRAYPACK - DPPS 532089

Basic unit, PS 3.21	-
HP hose DN6, 27 MPa, NPSM 1/4", 15 m	9984574
Pressure gauge set assy. HEA(MPa)	2383995
Airless Vector Grip gun, 1/4", incl. TradeTip 3 nozzle holder, with 2- and 4-finger trigger	538043
HEA ProTip 517	554517

ACCESSORIES

TradeTip 3 FineFinish nozzles, different sizes (e.g. tip 211 - Art. No. 517211)	554XXX
Nozzles TradeTip 3, different sizes	553XXX
Nozzle extension, 15 cm, G-thread	556074
Nozzle extension, 60 cm, G-thread	556077
TipClean; 200ml	2400215
EasyGlide, special oil, 118 ml	508619

PROSPRAY 3.25 SPRAYPACK



A compact emulsion unit for medium-sized objects

- **Innovative ProSpray product features:** Digital information readout and unit control directly on the device - piston oiled at the touch of a button - inlet valve depressor for high operating reliability - and more
- **Easy to handle:** Compact design for ease of transport and space-saving storage



- **Lightweight:** Just 17.9 kg (skid version) or 27.4 kg (cart version)
- **Two versions:** Available on trolley or as a compact Skid version

Clearly arranged: Digi-Trac-Control

With the digital display you can read out and handle machine data, consumption figures, runtimes and much more. The intelligent deadband control, SlowMotion function and FrequentClean guarantee trouble-free work and quick cleaning

Maintenance-free, brushless direct current motor:

Due to the improved performance, the motor works even more efficiently at low and also at high speeds. The continuous paint pressure measurement controls the motor speed automatically, thus ensuring a constant material pressure

Superb Spray Surface Quality: with the Vector Grip Airless gun. Light in weight with a long service life

Maintenance made easy: With the push of a button the piston is oiled and thus the packings are conserved

Inlet pusher valve: for a high operating reliability and easy commissioning. Just the press of a finger, and the valve is free

Also available as skid version



T ≤ 0.027"; **Y** 2.6 l/min

PROSPRAY 3.25 SPRAYPACK - DPPS

Basic unit, PS 3.25 on cart	-
HP hose DN6, 27 MPa, NPSM 1/4", 15 m	9984574
Airless Vector Grip gun, 1/4", incl. TradeTip 3 nozzle holder, with 2- and 4-finger trigger	538043
2SpeedTip, D10, 111 / 419	271045

PROSPRAY 3.25 SPRAYPACK - SKID VERSION 2308259

PROSPRAY 3.25 SPRAYPACK - CART VERSION 2308260

ACCESSORIES

TradeTip 3 FineFinish nozzles, different sizes (e.g. tip 211 - Art. No. 517211)	554XXX
Nozzles TradeTip 3, different sizes	553XXX
Nozzle extension, 15 cm, G-thread	556074
Nozzle extension, 60 cm, G-thread	556077
TipClean; 200ml	2400215
EasyGlide, special oil, 118 ml	508619



PROSPRAY 3.31 SPRAYPACK



A reliable unit for large-area emulsion work

- **Electronic control, information and management directly on the device:** displays the current pressure, pressure settings can be set and displayed, and much more
- **No-maintenance brushless motor**
- **High coverage performance together with easy operation**



operation

- **Innovative ProSpray product features:** Digital information readout and unit control directly on the device - tilting carriage - integrated high-pressure filter - and more

Superb Spray Surface Quality: with the Vector Grip Airless gun. Light in weight with a long service life

No nozzle blockages: The high pressure filter is easily accessible and quick to clean. Three different filter inserts (fine, medium, coarse) ensure an optimal match with the material

Tilting cart: Fast change of the container. Site-optimised tyres allow convenient pump transport

Clearly arranged - Digi-Trac-Control:

With the digital display you can read out and handle machine data, consumption figures, runtimes and much more. The intelligent deadband control, SlowMotion function and FrequentClean guarantee trouble-free work

Maintenance-free, brushless direct current motor:

Due to the improved performance, the motor works even more efficiently at low and also at high speeds. The continuous paint pressure measurement controls the motor speed automatically, thus ensuring a constant material pressure

T ≤ 0.032"; **Y** 3.8 l/min

PROSPRAY 3.31 SPRAYPACK - DPPS

Basic unit, ProSpray 3.31	-
HP hose DN6, 27 MPa, NPSM 1/4", 15 m	9984574
Airless Vector Grip gun, 1/4", incl. TradeTip 3 nozzle holder, with 2- and 4-finger trigger	538043
2SpeedTip, D20, 115/421	271046

ACCESSORIES

TradeTip 3 FineFinish nozzles, different sizes (e.g. tip 211 - Art. No. 517211)	554XXX
Nozzles TradeTip 3, different sizes	553XXX
Nozzle extension, 15 cm, G-thread	556074
Nozzle extension, 60 cm, G-thread	556077
TipClean; 200ml	2400215
EasyGlide, special oil, 118 ml	508619



PROSPRAY 3.34 SPRAYPACK



A technology masterpiece for high-viscosity materials such as flame retardants and corrosion-proofing products

- **This high-performance piston pump:** is ideally suited for large building sites where it is also able to handle high-viscosity materials
- **For large building sites:** Powerful and robust
- **Faster than ever:** Quick-change fluid section for ease of servicing and shorter reaction times



- **Innovative ProSpray product features:** Digital information readout and unit control directly on the device - tilting cart - integrated high-pressure filter - and more.

Superb Spray Surface Quality: with the Vector Grip Airless gun. Light in weight with a long service life

No nozzle blockages: The high pressure filter is easily accessible and quick to clean. Three different filter inserts (fine, medium, coarse) ensure an optimal match with the material

Tilting cart: Fast change of the container. Site-optimised tyres allow convenient pump transport

Clearly arranged: Digi-Trac-Control: With the digital display you can read out and handle machine data, consumption figures, runtimes and much more. The intelligent deadband control, SlowMotion function and FrequentClean guarantee trouble-free work and quick cleaning

Maintenance-free, brushless direct current motor: Due to the improved performance, the motor works even more efficiently at low and also at high speeds. The continuous paint pressure measurement controls the motor speed automatically, thus ensuring a constant material pressure

Low maintenance costs: The practical, self-adjusting packings lead to less wear and are easy to change. They have a service life up to 50% longer than comparable packings

Simple and quick: Change of the suction system without tools

≤ 0.034"; 4.5 l/min

PROSPRAY 3.34 SPRAYPACK - DPPS 2308263

Basic unit, PS 3.34	-
HP hose DN6, 27 MPa, NPSM 1/4", 15 m	9984574
Airless Vector Grip gun, 1/4", incl. TradeTip 3 nozzle holder, with 2- and 4-finger trigger	538043
2SpeedTip, D20, 115/421	271046

ACCESSORIES

TradeTip 3 FineFinish nozzles, different sizes (e.g. tip 211 - Art. No. 517211)	554XXX
Nozzles TradeTip 3, different sizes	553XXX
Nozzle extension, 15 cm, G-thread	556074
Nozzle extension, 60 cm, G-thread	556077
TipClean; 200ml	2400215
EasyGlide, special oil, 118 ml	508619



PROSPRAY 3.39 SPRAYPACK



Powerful emulsion unit for large areas

- **More power:** Greater suction performance thanks to the low position of the suction valve
- **Twice as fast with emulsion:** Parallel two-gun operation possible
- **The most powerful pump in the ProSpray family:** Even able to cope with Airless spraying fillers



- **Innovative ProSpray product features:** Tilting cart - change paints without using tools

Superb Spray Surface Quality: with the Vector Grip Airless gun. Light in weight with a long service life

No nozzle blockages: The high pressure filter is easily accessible and quick to clean. Three different filter inserts (fine, medium, coarse) ensure an optimal match with the material

Tilting cart: Fast change of the container. Site-optimised tyres allow convenient pump transport

Clearly arranged - Digi-Trac-Control: With the digital display you can read out and handle machine data, consumption figures, runtimes and much more. The intelligent deadband control, SlowMotion function and FrequentClean guarantee trouble-free work and quick cleaning

Maintenance-free, brushless direct current motor: Due to the improved performance, the motor works even more efficiently at low and also at high speeds. The continuous paint pressure measurement controls the motor speed automatically, thus ensuring a constant material pressure

Low maintenance costs: The practical, self-adjusting packings lead to less wear and are easy to change. They have a service life up to 50% longer than comparable packings

Also available as filler version with Airless gun AG 19

≤ 0.039"; 5 l/min

PROSPRAY 3.39 EMULSION SPRAYPACK - DPPS 2351261

Basic unit, PS 3.39	-
HP hose DN6, 27 MPa, NPSM 1/4", 15 m	9984574
Airless Vector Grip gun, 1/4", incl. TradeTip 3 nozzle holder, with 2- and 4-finger trigger	538043
2SpeedTip, D40, 117/427	271048
Double connector A = 1/4" NPS x 3/8" NPT	812-003
Double connector A = 3/8" NPT x A = 1/2" NPS	815-005

PROSPRAY 3.39 FILLER SPRAYPACK - DPPS 2308264

Basic unit, PS 3.39	-
HP hose DN13, max. 25 MPa, 3/8", NPSM 1/2", 15 m	2336585
Hose whip DN10, max. 25 MPa, NPSM 3/8", 2.5 m	2336582
Airless gun AG 19, 25 MPa, G-thread 3/8", incl. TradeTip 3 nozzle holder	2341127
2SpeedTip, S10, 235/527	271049
Coupling sleeve I = 1/4"NPSM x A = 3/8"NPSM, 27 MPa	179732
Connector 3/8" x 1/2"	814-005



HEAVYCOAT 750 E SPRAYPACK



Compact power pack for heavy material

- **Long service and reliability:** thanks to Hydra-stroke technology, the operating temperature is significantly reduced, thereby increasing the service life.
- **New hydraulic design:** inspired by mining and aviation for the toughest demands in terms of the piston pump's working and delivery performance.
- **Powerful:** constant performance for the application of



heavy, filled and high-viscosity materials such as bitumen and textured plaster over large areas.

- **Superb performance and perfect surface results:** even with long hoses.
- **Maximum user-friendliness:** thanks to simple operation.

It is a quick and easy task: to depressurise the unit

Hydrastroke technology: the operating temperature is reduced by up to 14°C in comparison to previous hydraulic systems

Container holder

Ease of maintenance: Pump and motor are easily accessible and the lower pump can be removed by loosening just 4 screws. This makes the HC 750 particularly maintenance-friendly

Ideal cooling: The robust design of the housing cover with integrated ventilation slots conducts air over all device components that convey hydraulic fluid



Quality spraying: with the high-performance gun AG 14. When used in combination with the 2SpeedTip nozzle for fillers, it is possible to handle even high-viscosity materials without difficulty

Available as an electrically driven or petrol-driven model: The basic model without SSP is also available with a petrol motor. This means that it can also be used on construction sites without an electrical connection

Large pneumatic tyres: mean that the unit is easy and comfortable to transport, even on difficult terrain

Low valve or optionally selectable SSP shovel piston: enable processing of extremely high-viscosity materials

≤ 0.043"; 6 l/min

HEAVYCOAT 750 E SPRAYPACK - DPHC 2371027

Basic unit, HC 750 E	-
HP hose DN13, max. 25 MPa, 3/8", NPSM 1/2", 15 m	2336585
Hose whip DN10, max. 25 MPa, NPSM 3/8", 2.5 m	2336582
Connector 3/8" x 1/2"	814-005
Airless gun AG 14, G-thread 1/4", incl. TradeTip 3 nozzle holder	0502081A
2SpeedTip, S10, 235/527	271049

ACCESSORIES

Airless gun AG 19, 25 MPa, G-thread 3/8", incl. TradeTip 3 nozzle holder	2341127
Airless Vector Grip gun, 1/4", incl. TradeTip 3 nozzle holder, with 2- and 4-finger trigger	538043
Nozzles TradeTip 3, different sizes	553XXX
Nozzles 2SpeedTip, different sizes	271XXX
TipClean; 200ml	2400215

HEAVYCOAT 950 SPRAYPACK



Power pack for the heaviest material

- **Versatile in use:** Thanks to high delivery capacity.
- **Powerful but light:** Compact for ease of transport.
- **Innovative HeavyCoat product features:** fast container changeovers, easy to clean and transport thanks to the swivelling SwingCart pump unit
- **SSP version:** with shovel piston for extra performance with high viscosity materials.



Quality spraying: with the high-performance gun AG 14. When used in combination with the 2SpeedTip nozzle for fillers, it is possible to handle even high-viscosity materials without difficulty

In a single action: the unit can be safely depressurised and quickly cleaned

HeavyCoat special hose: with a 3/8", 1/2" or 3/4" cross section for a better spraying performance

You have the choice: with or without SSP shovel piston for processing of very high-viscosity materials

Swing-Cart: makes it possible to swing up the pump. Practical when working from a bucket or a container but also for transport

Convenience: The adjustable height telescopic handle makes for convenient transport on the building site or in the in a vehicle

Tidied up: With the integral support hoses up to a length of 60 m can be practically stowed away



Construction-site-optimised tyres: avoid punctures and allow easy and convenient transport – even on difficult sites

≤ 0.052"; 6.6 - 8 l/min

HEAVYCOAT 950 SPRAYPACK - DPHC

Basic unit, HC 950 E	-
HP hose DN10, max. 25 MPa, NPSM 3/8", 15 m	2336583
Coupling sleeve I = 1/4"NPSM x A = 3/8"NPSM, 27 MPa	179732
Airless gun AG 14, G-thread 1/4", incl. TradeTip 3 nozzle holder	0502081A
2SpeedTip, D40, 117/427	271048

HEAVYCOAT 950 E SSP SPRAYPACK - DPHC 2332184

HEAVYCOAT 950 G SPRAYPACK - DPHC 2332186

HEAVYCOAT 950 E SSP SPRAYPACK - DPHC 2332187

Basic unit, HC 950 E SSP	-
HP hose DN13, max. 25 MPa, 3/8", NPSM 1/2", 15 m	2336585
Hose whip DN10, max. 25 MPa, NPSM 3/8", 2.5 m	2336582
Connector 3/8" x 1/2"	814-005
Airless gun AG 19, 25 MPa, G-thread 3/8", incl. TradeTip 3 nozzle holder	2341127
2SpeedTip, S20, 243/539	271050

HEAVYCOAT 970 SPRAYPACK

All-round Xtra speed for XL projects



- **WAGNER's most powerful hydraulic piston pump**
- **The perfect choice:** For large areas and intensive usage
- **Maximised capacity:** With a delivery volume of 10-12 l/min
- **Innovative HeavyCoat product features:** with a choice of either a petrol or electric motor which can be interchanged in a few minutes – or optionally even more



- power with SSP
- **Fast container changeovers, easy to clean and transport:** thanks to the swivelling SwingCart pump unit
- **SSP version:** with shovel piston for extra performance with high viscosity materials.

Quality spraying: in the high performance range too – with the AG 19 professional gun from WAGNER. In combination with the 2SpeedTip nozzle system even high viscosity materials can be sprayed without problems

Swing-Cart: makes it possible to swing up the pump. Practical when working from a bucket or a container but also for transport

Tidy: with the integral support hoses up to a length of 60 m can be practically stowed away

Convenience: The adjustable height telescopic handle makes for convenient transport on the building site or in the vehicle

With a choice of electric drive or independent of mains electricity with the Honda petrol engine:

The units can be converted from electric to petrol drive (or vice versa). This makes them able to be used on building sites with no power supply. Both motors are extremely reliable and longlasting



Construction-site-optimised tyres: avoid punctures and allow easy and convenient transport – even on difficult sites

T ≤ 0.056"; **Y** 10 - 12 l/min

HEAVYCOAT 970 SPRAYPACK - DPHC

Basic unit, HC 970 E / 970 G	-
HP hose DN13, max. 25 MPa, 3/8", NPSM 1/2", 15 m	2336585
Hose whip DN10, max. 25 MPa, NPSM 3/8", 2.5 m	2336582
Connector 3/8" x 1/2"	814-005
Coupling sleeve I = 1/4"NPSM x A = 3/8"NPSM, 27 MPa	179732
Airless gun AG 14, G-thread 1/4", incl. TradeTip 3 nozzle holder	0502081A
2SpeedTip, S20, 243/539	271050

HEAVYCOAT 970 E SPRAYPACK - DPHC 2332191

HEAVYCOAT 970 G SPRAYPACK - DPHC 2332193

HEAVYCOAT 970 E SSP SPRAYPACK - DPHC

Basic unit, HC 970 E SSP	2332193
HP hose DN13, max. 25 MPa, 3/8", NPSM 1/2", 15 m	2336585
Hose whip DN10, max. 25 MPa, NPSM 3/8", 2.5 m	2336582
Connector 3/8" x 1/2"	814-005
Airless gun AG 19, 25 MPa, G-thread 3/8", incl. TradeTip 3 nozzle holder	2341127
2SpeedTip, S20, 243/539	271050

SPIRAL PUMP

Simple operation – powerful and versatile



Do you appreciate the machine-based application of material, especially for harder tasks? Then a spiral pump from WAGNER is exactly the strong power packet you need for your construction sites. The robust, powerful performance of a spiral pump is delivered by a really simple rotor-stator function that WAGNER has been successfully using on the market for decades.



Robust, faithful reliable power packet for those difficult tasks:

Spiral pumps, also called eccentric spiral pumps, use displacement mechanisms to deliver the material. Two components, the rotor and the stator, are used for this. The rotor rotates and in doing so transports the material gently through the cavities of the stator. This simple function enables extremely heavy materials with different granulation and even fibres, such as render and other materials containing fillers, to be processed extremely efficiently.

The solution for heavy, textured material:

WAGNER spiral pumps can be used to achieve high-quality surfaces at a high working speed, for example with machine-assisted plaster application. Here the heavy, highly viscous material is moved with the help of the spiral pump through the hose to the spray gun, where it is atomized and applied smoothly. Comfortable and controlled, just like you're used to with WAGNER airless spray devices.

1. EASY TO OPERATE:

The simple, user-friendly operating concept for controlling the rotor and stator guarantees problem-free use, even for beginners.

2. FAST CLEANING:

WAGNER spiral pumps can be quickly disassembled for cleaning and maintenance and reassembled again thanks to the simple stator design, including directly on the construction site. This is made especially easy on the WAGNER PlastCoat 1030 by the automatic stator withdrawal. The material-carrying parts are also made from special materials which are easy to clean.

3. LONG SERVICE LIFE:

WAGNER spiral pumps are robust and easy to use. They are especially low-wear and low-maintenance, and are considerably quieter in operation than conventional piston pumps.

CROSS-SECTION OF THE SPIRAL PUMP

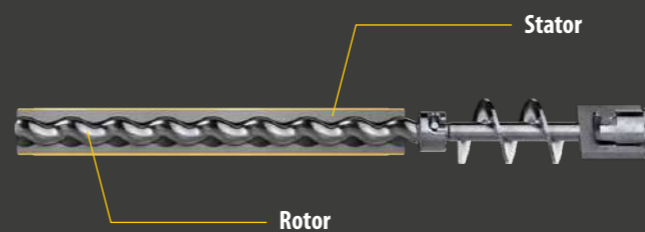

ADVANTAGES

- Simple and sturdy technology
- Gentle material transport
- Powerful processing of highly viscous materials
- Fully adjustable control of spray pressure
- Long lifespans
- Low maintenance

PLASTCOAT HP 30



Uniting the best – Robust high-pressure spiral pump with airless technology for high-viscosity fillers

- **Simplest handling:** The user-friendly operating concept enables error-free application – even for beginners.
- **The ergonomic airless gun and the high pressure hose:** guarantee a high level of operating comfort during material application.
- **Maximum performance:** The PlastCoat HP 30 provides a convincing delivery capacity of >10kg/min.



The spraying pressure can also be freely adjusted (40-120 bar).

- **Exceptionally reliable:** The low-wear and low-maintenance spiral pump is characterised by its robust and proven technology.

Plastic material hopper: Easy to clean and with a capacity of 50 litres. Cover for the material hopper available separately as an accessory (Art. No. 2400 030)

Compact dimensions: With a height of 62 cm, the device can easily be filled with material

High-performance guns: With the airless gun AG 19, even high-viscosity materials can be processed without any problems

Colour-coordinated pressure gauge: Allows perfect control of the pressure in coordination with the material being processed

Easy control: Thanks to the user friendly control panel

Perfect for every construction site: The large, pneumatic tyres ensure mobility on any construction site

Quiet and comfortable airless spraying: without additional compressor with up to 120 bar working pressure

HEA HIGH EFFICIENCY AIRLESS

NEW

Can easily be converted for emulsion work: With the emulsion kit comprising a 15 m hose (DN 10) and the Vector Pro gun with HEA nozzle 517 (2400684)

HEA HIGH EFFICIENCY AIRLESS

≤ 0.055" ; > 10 kg/min

PLASTCOAT HP 30 SPRAYPACK - DPPC 2388301

Basic unit, PC HP 30	-
HP hose Ø19, 10m	2390763
HP whip hose, DN10, 2.5 m	2390762
Airless gun AG 19, 25 MPa, G-thread 3/8", incl. TradeTip 3 nozzle holder	2341127
TradeTip 3 nozzle 443	553443
PlastGuard longlasting pump protector	2399960

EMULSION SET PLASTCOAT HP 30 2400684

Airless gun Vector Pro, 1/4", incl. TradeTip 3 nozzle holder, with 4-finger trigger	538040
HP hose DN10, max. 25 MPa, NPSM 3/8", 15 m	2336583
HEA ProTip nozzle 517	554517
Adapter FM 1/2BSPP-3/8NPSM	2332623
Adapter FM 1/4 NPSM-3/8NPSM	179732

PRACTICAL ACCESSORIES HP 30

HOSES

HP hose Ø19, 10m	2390763
HP whip hose, DN10, 2.5m	2390762
HP hose DN10, max. 25 MPa, NPSM 3/8", 15 m	2336583

SPRAY GUNS AND NOZZLES

Airless gun AG 19, 25 MPa, G-thread 3/8", incl. TradeTip 3 nozzle holder	2341127
Airless gun Vector Pro, 1/4", incl. TradeTip 3 nozzle holder, with 4-finger trigger	538040
TradeTip 3 nozzles, different sizes	0553XXX
HEA ProTip nozzles, different sizes	0554XXX
Nozzle holder, G-thread 7/8", for TradeTip 3 nozzles	0289390

OTHER

Nozzle extension, 30 cm, G-thread	556075
Nozzle extension, 60 cm, G-thread	556077
Cleaning ball DN16	2402355
Cleaning ball DN19	342330
Rotor and stator, complete, for PlastCoat HP 30	2395996
Cover for material hopper	2400030
Press table	2389048
PlastGuard pump protector	2399959
PlastGuard longlasting pump protector	2399960

RECOMMENDED USE

MATERIALS:

Emulsion and latex paints, adhesives, sealants	Structural waterproofing, bituminous coatings
Exterior paints, roof coatings, floor coatings, textured paint	Filler

OBJECT SIZE:



TECHNICAL DATA

Weight	72 kg
Motor power	2.3 kW
Voltage	230 V / 50 Hz
Max. operating pressure	120 bar, 12 MPa
Max. delivery rate (airless emulsion spray filler)	> 10 kg / min
Max. feed height	20 m
Max. delivery radius	22.5 m
Max. grain size *	0.3 mm

*Airless fillers, emulsion fillers

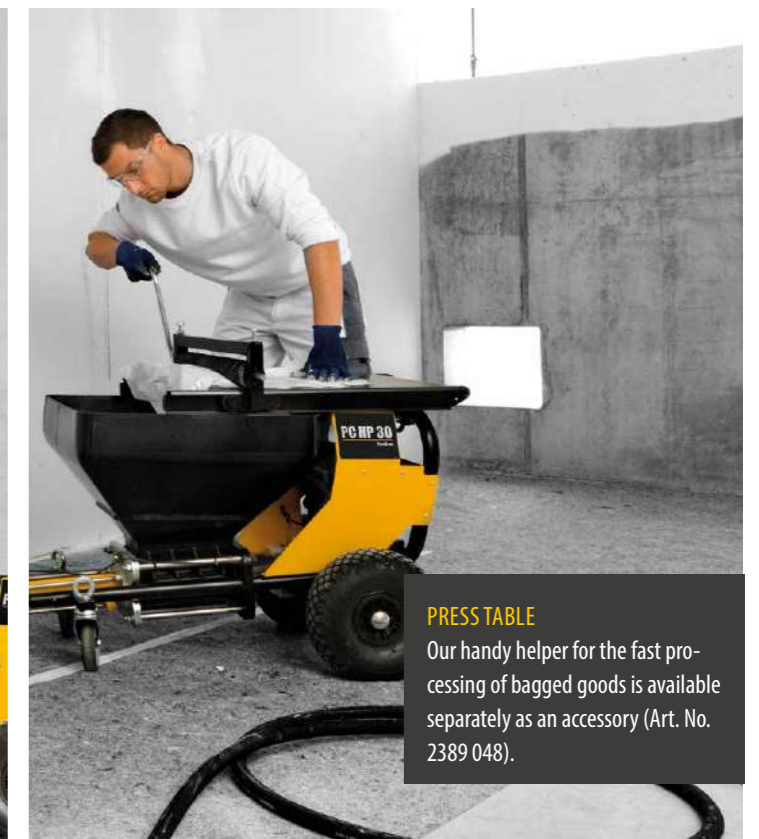

PRESS TABLE
Our handy helper for the fast processing of bagged goods is available separately as an accessory (Art. No. 2389 048).

PLASTCOAT 830 E SPRAYPACK



High-performance plaster spraying system for large areas

- **Professional coverage of large areas:** powerful motor and integrated material container
- **Practical:** Automatic stator extraction for easy cleaning
- **Wide range of possibilities:** Rounded off by accessories such as bag presses
- **Easy to transport:** Easy to dismantle



- **Possibility to switch the pump on or off directly at the spray lance (electrically)**

High-quality plastic container: with a capacity of 45 liters and a low weight. It is easy to clean, flexible, weather and ageing resistant

Powerful servo motor: achieves high torques and guarantees perfect performance

Ergonomic spraying lance: Due to its modular construction and accessories (e.g. the lance extension) the spraying lance can adapt quickly to any project

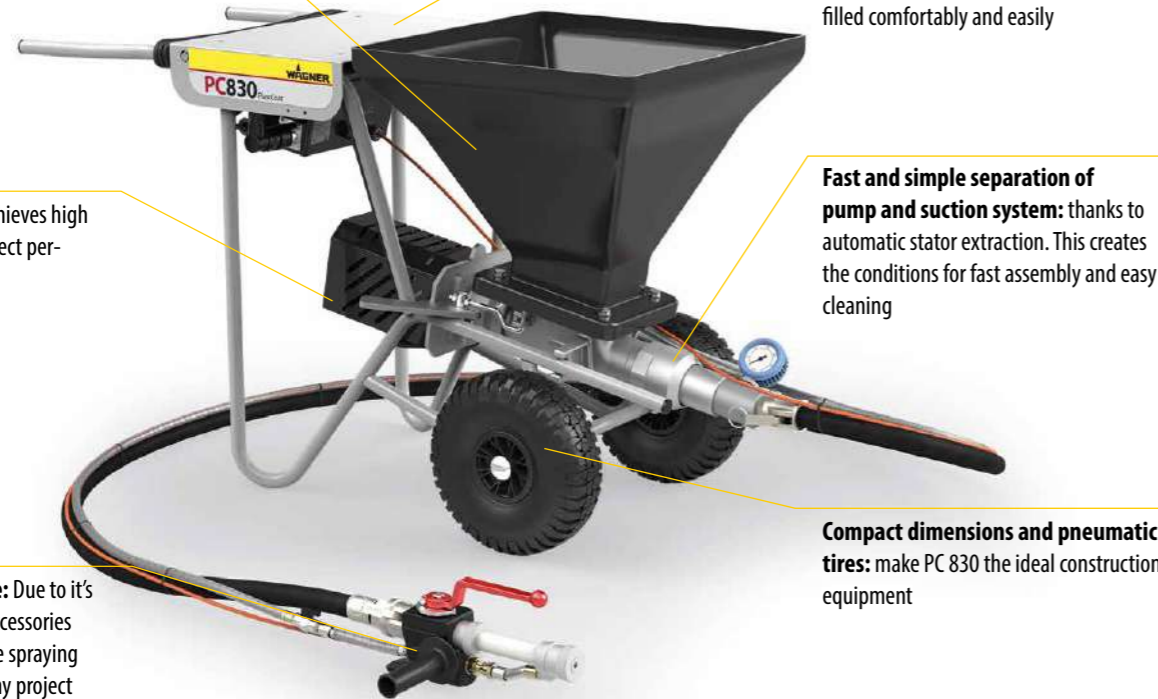

Optionally PC 830 is available with a sack press table including roller press: This allows to squeeze bags of filler easily and conveniently. The stable table serves as a placement area for bags of filler or buckets. The hopper can be filled comfortably and easily

Fast and simple separation of pump and suction system: thanks to automatic stator extraction. This creates the conditions for fast assembly and easy cleaning

Compact dimensions and pneumatic tires: make PC 830 the ideal construction equipment



12 l/min

PLASTCOAT 830 E SPRAYPACK - DPPC 2308305

Basic unit, PC 830 E	-
Mortar hose DN25, M/V35, 10 m, including air hose and control cable	2325197
Spraying lance, automatic, incl. 6 mm nozzle	2334115
Pump lubricant 500 ml	9992824
Tool bag	3799003

ACCESSORIES

Spraying lance, automatic, incl. 6 mm nozzle	2334115
Glue attachment	2335394
Spray lance extension, 80 cm	2334123



PLASTCOAT 1030 E SPRAYPACK



The power to handle large volumes – compact and versatile

- **Compact and lightweight:** 58 kg of weight with a delivery height of 20 m and delivery radius of 40 m, materials up to a grain size of 6 mm supported
- **Easy cleaning for use on building sites:** automatic stator extraction and automatic pressure release
- **For large surfaces and easy transport:** integrated 50-litre plastic container, four wheels and a low overall



- height
- **Maintenance-free and robust:** brushless DC motor for a high torque
- **Closing the gun turns off the pump (electrically)**

Plastic materialhopper: for an easy cleaning with a capacity of up to 50 litre

Included in scope of delivery: PC 1030 comes complete ready to spray incl. mortar hose (DN 25, 10 m), automatic spraying lance with nozzle and toolbox

Perfectly equipped for all construction sites: Big, pneumatic tires ensures mobility on all construction sites



15 l/min

PLASTCOAT 1030 E SPRAYPACK - DPPC 2361588

Basic unit, PlastCoat 1030 E	-
Mortar hose DN25, M/V35, 10 m, including air hose and control cable	2325197
Spraying lance, automatic, incl. 6 mm nozzle	2334115
Pump lubricant 500 ml	9992824
Tool box, premium, without content	348450

Compact dimensions: With a height of 62 cm the unit can be easily filled using buckets or combined with a flow mixer

Automatic stator extraction: Fast separation of pump and suction system, also great for quick assembly. Ideal for easy cleaning and transport

Ergonomic spraying lance: Due to its modular construction and accessories (e.g. the lance extension) the spraying lance can adapt quickly to any project

ACCESSORIES

Pump worm W10/3, Ø = 40 mm, L = 320 mm, yellow	348316
Pump worm W15/2, Ø = 40 mm, L = 320 mm, brown	348926
Pump casing W10/3, 270x89, yellow	348315
Pump casing W15/2, 270x89, brown	348925



PLASTMAX SPRAYPACK



Versatile mixing pump for the economical application of mineral and viscous materials

- **Complete solution:** Mixing, pumping and spraying with a single unit
- **User-friendly and powerful:** clearly arranged control panel including speed inverter and material flow rate
- **Easy transport and quick cleaning:** the tiltable mixing chamber and the quick stator changing allow an easy cleaning. For transport the unit can be disassembled into



- four modules
- **Easy to maintain and durable:** self-priming water pump with stainless steel case and brass impeller
 - **Integrated compressor:** dirt resistant and oil-free compressed air for low maintenance

Bag opener: allows quick filling of the material container.

Easy to handle: thanks to clearly laid-out control panel.

Durable compressor: unaffected by dirt thanks to oil-free compressed air.



Maximum safety at work: the integrated safety grille and comfortable filling height ensure safe and ergonomical working.

Large material funnel: avoids interruption of work as material only requires refilling infrequently.

Easy cleaning and assembly: the angle of inclination can be adjusted with a lever.



15 l/min

PLASTMAX SPRAYPACK - DPPC **2361587**

Base unit, PlastMax	-
Mortar hose DN25, M/V25, 10 m incl. air hose	2325182
In-wall lance, pneumatic	2334122
Accessory box, complete, for PlastMax	2362233

ACCESSORIES

PlastMax Mixing shaft, light materials	2366915
Rotor PlastMax D5-2,5	2363614
Stator PlastMax D5 - 2,5	2363615
Stator PlastMax D4-1/2	2366948
Rotor PlastMax D4-1/2	2366947
Rotor PlastMax D4 -1/4	2366951

TEMPSPRAY AIRLESS HEATED HOSE

Optimised for spraying highly viscous materials without dilution



Would you always like to ensure the ideal processing temperature and best viscosity of the material you are spraying, regardless of any seasonal fluctuations in temperature? The TempSpray heated hose from WAGNER is your guarantee for the best possible surface quality. The electric heating element, located directly in the flow of paint inside the hose system, heats the material evenly over the entire length of the hose to the pre-set temperature.



Heat up instead of diluting:

The ideal viscosity, along with the right working technique and equipment, are crucial for impressive results when spraying. If material is too thick, the result is an irregular spray pattern and a poor paint application. To make coating materials sprayable they usually have to be diluted. Heating the material with a TempSpray heated hose system from WAGNER has the same effect: viscosity is reduced, improving the application of the material. The result is a soft spray pattern and optimised atomisation quality.

Perfectly equipped for every area of application:

Heating the material in the heated hose improves the spraying properties of numerous coating materials - from stains and lacquers through to adhesives. The TempSpray systems can be fully controlled from 20° to 60°C. They can be used with all WAGNER airless devices, offering a broad range of applications.

1. LESS SOLVENT, VOC-COMPLIANT:

Heating the material reduces the amount of solvent needed since the material no longer needs to be diluted to achieve the required spray viscosity.

2. LOWER SPRAY PRESSURE:

Heating reduces the material's viscosity, allowing a lower spray pressure to be used. This reduces the overspray, protects the device being used and also protects the operator.

CHANGE IN VISCOSITY

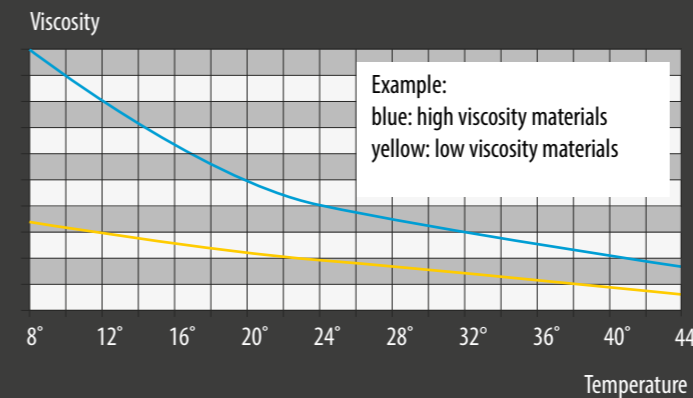

ADVANTAGES

- Easy to use
- Reduction of overspray
- Paint savings thanks to less overspray
- Increase in the thickness of the layers applied
- Less wear and tear on the device
- Constant paint temperature, even when outdoor temperatures are low
- Excellent edge coverage

TEMPSPRAY H 126 SPRAYPACK



The system that simplifies your work – perfect surface finishes through reduced viscosity with material heating

- **Easy to use:** specially designed for paint jobs, easily adapted for use with all Airless devices
- **Effortless operation:** flexible, steel-reinforced DN6 hose
- **Flexible:** continuous temperature regulation from 20° C - 60° C
- **Lightweight:** weighs only 3.5 kg



- **Suitable for the following materials:** wood preservative, oils, stains, primers, undercoats, fillers, lacquers, 2K materials (Check the pot life)

TEMPSPRAY H 226 SPRAYPACK



Practical material heating system – for emulsions and latex paints

- **Specially designed for emulsions, latex paints**
- **Practical:** trolley-mounted hose reel for simple transportation on building sites
- **Flexible:** for indoor and outdoor use, easily adapted to all Airless units
- **Suitable for the following materials:** thick materials, high solids, emulsion paints, latex paints, exterior protection, roof coatings



Spray with excellent surface quality: the Vector Grip Airless gun is lightweight and has a long service life

Perfect surface finish with TempSpray: heating of the coating material produces a soft spray pattern and therefore perfect atomisation. Other advantages include less overspray, perfect viscosity without dilution and much more

Also available as a base unit for combining with existing Airless guns



Also ideal in combination with AirCoat for very fine atomisation



Clearly laid-out control unit: the required temperature can be fully adjusted from 20°C to 60°C as needed by pressing the arrow buttons

Compact unit: thanks to integrated heating element

Flexible and robust: 10-metre-long DN6 stainless steel hose

TEMPSPRAY H 126 SPRAYPACK - DPTS 2311852

TempSpray H 126 Basic Unit, 10 m	2311659
Airless Vector Grip gun, 1/4", incl. TradeTip 3 nozzle holder, with 2- and 4-finger trigger	538043
2SpeedTip, L10, 208 / 510	271042

BASIC UNIT

TempSpray H 126 Basic Unit, 10 m	2311659
----------------------------------	---------

TEMPSPRAY H 126 AIRCOAT SPRAYPACK - DPTS

TempSpray H 126 Basic Unit, 10 m	2311659
AirCoat gun AC 4600 Professional, incl. blue air cap and holder	394156
Air hose DN6, 10 cm, for AirCoat applications	344905

Spray with excellent surface quality: The Airless Gun AG 14 is robust and has a long service life

Mobile: thanks to construction site-compatible reel drum

Also available as a base unit for combining with existing Airless guns



Clearly laid-out control unit: the required temperature can be fully adjusted from 20°C to 60°C as needed by pressing the arrow buttons

Perfect surface finish with TempSpray: heating of the coating material produces a soft spray pattern and therefore perfect atomisation. Other advantages include less overspray, perfect viscosity without dilution and much more

BASIC UNIT

TempSpray H 226 Basic Unit, 15 m	2311660
----------------------------------	---------

TEMPSPRAY H 226 SPRAYPACK - DPTS 2311853

TempSpray H 226 Basic Unit, 15 m	2311660
Airless gun AG 14, G-thread 1/4", incl. TradeTip 3 nozzle holder	0502081A
2SpeedTip, D10, 111 / 419	271045

TEMPSPRAY H 326 SPRAYPACK



The longest TempSpray of all time – for extended versatility and working radius

- **Ideal for emulsions, masonry, facade paints**
- **Twice the working radius for indoor and outdoor work:** 30 m heated hose
- **Practical:** large trolley-mounted hose reel for simple transportation on building sites
- **Suitable for the following materials:** thick materials, high solids, emulsion paints, latex paints, exterior



protection, roof coatings, corrosion proofing, bitumen, adhesives

Superb Spray Surface Quality: with the AG 14 Airless gun. Robust with a long service life

Mobile: thanks to construction site-compatible reel drum and extra-long hose (30 m)

Also available as a basic unit for use with existing airless guns



Clear control unit: By pressing the arrow buttons, the desired temperature can be continuously adjusted from 20°C - 60°C as required

Perfect finish with TempSpray: Thanks to warming up the coating material a very soft spray pattern is generated. This increases the atomisation quality. Further advantages are less overspray, a perfect viscosity without thinning and much more

NOTES

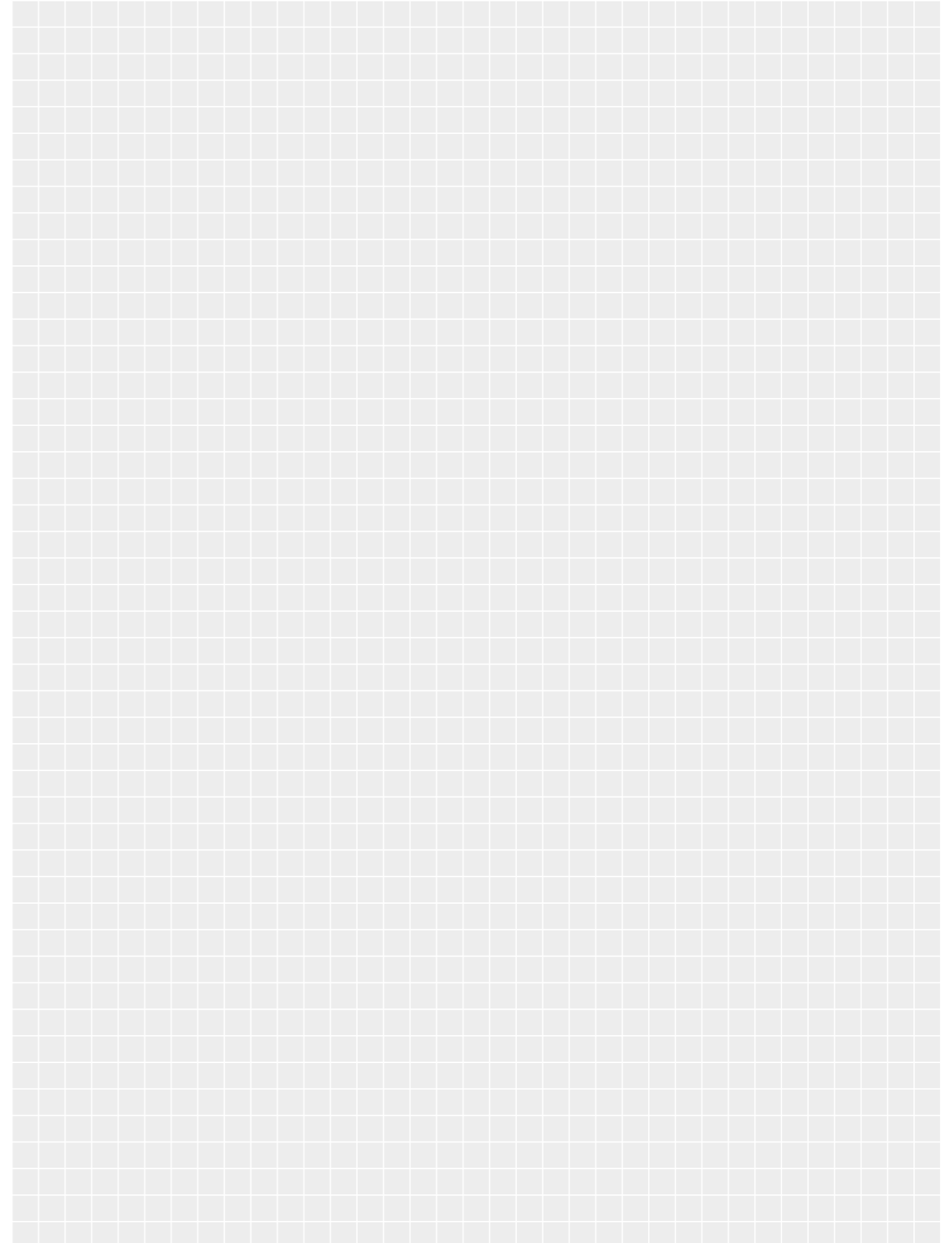

BASIC UNIT

TempSpray H 326 Basic Unit, 30 m

2311661

TEMPSPRAY H 326 SPRAYPACK - DPTS

2311854

TempSpray H 326 Basic Unit, 30 m

2311661

Airless gun AG 14, G-thread 1/4", incl. TradeTip 3 nozzle holder

0502081A

2SpeedTip, D20, 115 / 421

271046

NOZZLES

The heart of the spraying process

Across all technologies – Airless, AirCoat, plaster spraying with worm pumps, HVLP or XVL P – nozzles and air caps play a decisive role in surface quality. In addition to the actual pump, they are the true heart of the spraying process. This is where the material is atomised and where the fineness of the droplet formation in the spray pattern is determined. The nozzle size also determines the quantity of material forced through the bore. Top-quality nozzles are a prerequisite for premium surface finishes in line with your professional standards.



- Water and solvent-based lacquers, lacquer paints, oils, separating agents
- Synthetic resin lacquers, PVC lacquers, 2K lacquers
- Primers, fillers
- Fire protection, rust protection paints
- Emulsion and latex paints, adhesives, sealants
- Exterior paints, roof coatings, floor coatings
- Structural waterproofing, bituminous coatings
- Filler
- Plaster



AIRLESS TRADETIP 3 NOZZLES – PERFECT AND DURABLE

Art. no. 553xxx The yellow standard nozzle covers a wide spectrum of applications using primers, enamels and lacquers.

		Orifice size (inch)																												
		0,007	0,009	0,011	0,013	0,015	0,017	0,019	0,021	0,023	0,025	0,027	0,029	0,031	0,033	0,035	0,039	0,043	0,045	0,051	0,052	0,055	0,061	0,063	0,065	0,067				
Jet width (mm)*	100	107	109	111	113	115	117																							
	120	207	209	211	213	215	217	219	221	223	227	229	231	233	235		243				252		261	263		267				
	150	307	309	311	313	315	317	319	321	323	325	327	329	331	333	335														
	190	407	409	411	413	415	417	419	421	423	425	427	429	431	433	435	439	443	445	451		455	461	463		467				
	225		509	511	513	515	517	519	521	523	525	527	529	531	533	535	539	543	545	551		555	561		565					
	270		609	611	613	615	617	619	621	623	625	627	629	631	633	635	639	643		651		655	661		665					
	300					715	717	719	721	723	725			731		735														
	330				813	815	817	819	821	823	825	827		831																
	385							919																						
	Flow rate (l/min)**		0,19	0,34	0,45	0,68	0,91	1,17	1,47	1,78	2,15	2,53	2,95	3,44	3,89	4,42	4,99	6,20	7,52	8,24	10,58									
Filter		red			yellow			white						green																



HEA PROTIP NOZZLES – UP TO 55 % LESS OVERSPRAY

Art. no. 554xxx The new WAGNER HEA ProTip airless nozzle provides a perfect surface finish at reduced spraying pressure. Compared to standard airless technology the spray pattern is gently feathered and free from edge strips.

		Orifice size (inch)						Spray angle in °
		0,011	0,013	0,015	0,017	0,019	0,021	
Jet width (mm)*	120	211	213					20
	150	311	313					30
	190	411	413	415	417		421	40
	225			515	517	519	521	50
	270			615	617	619	621	60
Flow rate (l/min)**		0,45	0,68	0,91	1,17	1,47	1,78	
Filter		red		yellow		white		



AIRLESS TRADETIP 3 FINEFINISH

Art. no. 554xxx Top paint nozzle with optimised third-generation properties. With double special core for ultra-fine droplet formation and exceptionally high-quality surfaces, even in low pressure ranges. FineFinish nozzles are coloured purple.

		Orifice size (inch)				Spray angle in °
		0,008	0,010	0,012	0,014	
Jet width (mm)*	120	208	210	212	214	20
	150	308	310	312	314	30
	190	408	410	412	414	40
	225		510	512	514	50
Flow rate (l/min)**		0,26	0,42	0,6	0,79	
Filter		red				

* Spray width (mm) at approx. 30 cm distance from the object and 100 bar pressure, with synthetic resin paint, 20 DIN seconds
 ** Measured with water at 120 bar pressure

	FINISHCONTROL 3500	FINISHCONTROL 5000	FINECOAT 9900 PLUS	CONTROLPRO 350 EXTRA SKID VERSION	CONTROLPRO 350 EXTRA CART VERSION
Spraying method					
Product image (may differ)					
Art. No.	2341501	2316090	276048	2371061	2371065
Categorie	DPXVLP	DPXVLP	DPFC	DPPPE	DPPPE
Price €	550,00	865,00	2.300,00	750,00	880,00
Technology					
Weight	2.3 kg	8 kg	10 kg	7.6 kg	13 kg
Motor output	0.7 kW	1.4 kW	1.5 kW	0.6 kW	0.6 kW
Drive					
Voltage	230 V / 50 Hz	230 V / 50 Hz	230 V / 50 Hz	230 V / 50 Hz	230 V / 50 Hz
Max. nozzle size	-	-	-	0.019"	0.019"
Max. operating pressure	0.2 bar, 0.02 MPa	0.275 bar, 0.0275 MPa	0.72 bar, 0.072MPa	110 bar, 11 MPa	110 bar, 11 MPa
Max. delivery rate	-	-	-	1.5 l/min	1.5 l/min
Max. viscosity	-	-	-	-	-
Recommended max. hose length	-	-	-	15 m	15 m
Material					
Recommended intensity					

	SUPERFINISH 23 PRO HEA	SUPERFINISH 23 PLUS HEA	SUPERFINISH 23 PLUS TEMPSPRAY CART VERSION	SUPERFINISH 23 PLUS AIRLESS ENAMEL CART VERSION	SUPERFINISH 23 PLUS AIRCOAT ENAMEL CART VERSION
Spraying method					
Product image (may differ)					
Art. No.	2399198	2384153	2341496	2341492	2341490
Categorie	DPFSF	DPFSF	DPFSF	DPFSF	DPFSF
Price €	2.200,00	3.625,00	5.530,00	3.625,00	4.125,00
Technology					
Weight	27 kg	29 kg	29 kg	29 kg	29 kg
Motor output	1.3 kW	1.3 kW	1.3 kW	1.3 kW	1.3 kW
Drive					
Voltage	230 V / 50 Hz	230 V / 50 Hz	230 V / 50 Hz	230 V / 50 Hz	230 V / 50 Hz
Max. nozzle size	0.023"	0.023"	0.023"	0.023"	0.023"
Max. operating pressure	250 bar, 25 MPa	250 bar, 25 MPa	250 bar, 25 MPa	250 bar, 25 MPa	250 bar, 25 MPa
Max. delivery rate	2.6 l/min	2.6 l/min	2.6 l/min	2.6 l/min	2.6 l/min
Max. viscosity	20.000 mPas	20.000 mPas	20.000 mPas	20.000 mPas	20.000 mPas
Recommended max. hose length	30 m	30 m	10 m	30 m	7,5 m
Material					
Recommended intensity					

Water and solvent-based lacquers, lacquer paints, oils, separating agents

Synthetic resin varnishes, PVC lacquers, 2K lacquers

Primers, fillers

Fire protection, rust protection paints

Emulsion and latex paints, adhesives, sealants

Exterior paints, roof coatings, floor coatings, textured paint

Structural waterproofing, bituminous coatings



























Filler































Plaster

Residential

Large residential

Commercial

	COBRA 40-10 AIRCOAT	SUPERFINISH 23 INJECTION	SUPERFINISH 33 PLUS	SUPERFINISH 33 PRO	POWERPAINTER 90 EXTRA
Spraying method		Injection			
Product image (may differ)					
Art. No.	322112	2361599	2388259	2388260	2401275
Categorie	ILGR	DPFSF	DPFSF	DPFSF	DPPPE
Price €	4.750,00	3.010,00	6.030,00	5.380,00	1.020,00
Technology					
Weight	19 kg	29 kg	50 kg	43 kg	23 kg
Motor output	-	1.3 kW	2.2 kW	2.2 kW	0.8 kW
Drive					
Voltage	-	230 V / 50 Hz	230 V / 50 Hz	230 V / 50 Hz	230 V / 50 Hz
Max. nozzle size	0.023"	-	0.033"	0.033"	0.019"
Max. operating pressure	250 bar, 25 MPa	250 bar, 25 MPa	250 bar, 25 MPa	250 bar, 25 MPa	207 bar, 20.7 MPa
Max. delivery rate	2 l/min	2.6 l/min	4.2 l/min	4.2 l/min	1.6 l/min
Max. viscosity	-	20.000 mPas	20.000 mPas	20.000 mPas	-
Recommended max. hose length	7,5 m	15 m	60 m	60 m	15 m
Material					
Recommended intensity					

	PROSPRAY 20 HEA	PROSPRAY 3.21 HEA	PROSPRAY 3.25 CART VERSION	PROSPRAY 3.25 SKID VERSION	PROSPRAY 3.31
Spraying method					
Product image (may differ)					
Art. No.	2403616	532089	2308260	2308259	2308262
Categorie	DPPS	DPPS	DPPS	DPPS	DPPS
Price €	2.160,00	2.930,00	4.010,00	3.685,00	6.495,00
Technology					
Weight	15.2 kg	17.9 kg	27.4 kg	17.9 kg	43.5 kg
Motor output	0.9 kW	1.03 kW	1.1 kW	1.1 kW	1.84 kW
Drive					
Voltage	230 V / 50 Hz	230 V / 50 Hz	230 V / 50 Hz	230 V / 50 Hz	230 V / 50 Hz
Max. nozzle size	0.021"	0.023"	0.027"	0.027"	0.032"
Max. operating pressure	214 bar, 21.4 MPa	221 bar, 22.1 MPa	221 bar, 22.1 MPa	221 bar, 22.1 MPa	221 bar, 22.1 MPa
Max. delivery rate	1.6 l/min	2 l/min	2.6 l/min	2.6 l/min	3.8 l/min
Max. viscosity	20.000 mPas	20.000 mPas	25.000 mPas	25.000 mPas	25.000 mPas
Recommended max. hose length	30 m	30 m	30 m	30 m	60 m
Material					
Recommended intensity					

 Water and solvent-based lacquers, lacquer paints, oils, separating agents

 Synthetic resin varnishes, PVC lacquers, 2K lacquers

 Primers, fillers

 Fire protection, rust protection paints

 Emulsion and latex paints, adhesives, sealants

 Exterior paints, roof coatings, floor coatings, textured paint

 Structural waterproofing, bituminous coatings

 Filler

 Plaster

 Residential

 Large residential

 Commercial

	PROSPRAY 3.34	PROSPRAY 3.39 EMULSION	PROSPRAY 3.39 FILLER	HEAVYCOAT 750 E	HEAVYCOAT 950 E
Spraying method					
Product image (may differ)					
Art. No.	2308263	2351261	2308264	2371027	2332184
Categorie	DPPS	DPPS	DPFSF	DPHC	DPHC
Price €	7.210,00	7.535,00	7.635,00	7.500,00	8.895,00
Technology					
Weight	47.6 kg	50 kg	50 kg	85 kg	83 kg
Motor output	1.95 kW	2.19 kW	2.19 kW	3.1 kW	3.6 kW
Drive					
Voltage	230 V / 50 Hz	230 V / 50 Hz	230 V / 50 Hz	230 V / 50 Hz	230 V / 50 Hz
Max. nozzle size	0.034"	0.039"	0.039"	0.043"	0.052"
Max. operating pressure	221 bar, 22.1 MPa	221 bar, 22.1 MPa	221 bar, 22.1 MPa	250 bar, 25 MPa	250 bar, 25 MPa
Max. delivery rate	4.5 l/min	5 l/min	5 l/min	6 l/min	6.6 l/min
Max. viscosity	25.000 mPas	30.000 mPas	30.000 mPas	50.000 mPas	50.000 mPas
Recommended max. hose length	60 m	60 m	60 m	100 m	100 m
Material					
Recommended intensity					

	HEAVYCOAT 950 G	HEAVYCOAT 970 E	HEAVYCOAT 970 G		
Spraying method					
Product image (may differ)					
Art. No.	2332186	2332191	2332192		
Categorie	DPHC	DPPS	DPPS		
Price €	9.4200,00	9.630,00	10.155,00		
Technology					
Weight	76 kg	100 kg	88 kg		
Motor output	4.1 kW	5.5 kW	6 kW		
Drive					
Voltage	230 V / 50 Hz	400 V / 50 Hz	-		
Max. nozzle size	0.052"	0.056"	0.056"		
Max. operating pressure	250 bar, 25 MPa	250 bar, 25 MPa	250 bar, 25 MPa		
Max. delivery rate	8 l/min	10 l/min	12 l/min		
Max. viscosity	50.000 mPas	65.000 mPas	65.000 mPas		
Recommended max. hose length	100 m	100 m	100 m		
Material					
Recommended intensity					

Water and solvent-based lacquers, lacquer paints, oils, separating agents

Synthetic resin varnishes, PVC lacquers, 2K lacquers

Primers, fillers

Fire protection, rust protection paints

Emulsion and latex paints, adhesives, sealants

Exterior paints, roof coatings, floor coatings, textured paint

Structural waterproofing, bituminous coatings

Filler

Plaster

Residential

Large residential

Commercial

	PLASTCOAT HP 30	PLASTCOAT 830 E	PLASTCOAT 1030 E	PLASTMAX
Spraying method				
Product image (may differ)				
Art. No.	2388301	2308305	2361588	2361587
Categorie	DPPC	DPPS	DPPS	DPPS
Price €	6.900,00	4.205,00	5.475,00	7.580,00
Technology				
Weight	72 kg	47 kg	59 kg	178 kg
Motor output	2.3 kW	1.8 kW	2.2 kW	3.2 kW
Drive				
Voltage	230 V / 50 Hz	230 V / 50 Hz	230 V / 50 Hz	230 V / 50 Hz
Max. nozzle size	0.055"	-	-	-
Max. operating pressure	120 bar, 12 MPa	40 bar, 4 MPa	40 bar, 4 MPa	40 bar, 4 MPa
Max. delivery rate	> 10 kg/min	12 l/min	15 l/min	15 l/min
Max. viscosity	-	-	-	-
Max. grain size	-	K3 mm	K6 mm	K6 mm
Recommended max. hose length	22,5 m	20 m	40 m	30 m
Material				
Recommended intensity				

Water and solvent-based lacquers, lacquer paints, oils, separating agents

Fire protection, rust protection paints

Structural waterproofing, bituminous coatings

Residential

Synthetic resin varnishes, PVC lacquers, 2K lacquers

Emulsion and latex paints, adhesives, sealants

Filler

Large residential

Primers, fillers

Exterior paints, roof coatings, floor coatings, textured paint

Plaster

Commercial

	TEMPSPRAY H 126 BASIC UNIT	TEMPSPRAY H 126 SPRAYPACK	TEMPSPRAY H 226 BASIC UNIT	TEMPSPRAY H 226 SPRAYPACK
Spraying method	-		-	
Product image (may differ)				
Art. No.	2311659	2311852	2311660	2311853
Categorie	DPTS	DPTS	DPTS	DPTS
Price €	1.885,00	2.250,00	2.680,00	3.175,00
Technology				
Weight	3.2 kg	-	18 kg	-
Drive				
Voltage	230 V / 50 Hz	230 V / 50 Hz	230 V / 50 Hz	230 V / 50 Hz
Power connection cable	4 m	4 m	6 m	6 m
Heater power	0.6 kW	0.6 kW	1.3 kW	1.3 kW
Recommended max. hose length	10 m	10 m	15 m	15 m
Max. operating pressure	250 bar, 25 MPa	250 bar, 25 MPa	250 bar, 25 MPa	250 bar, 25 MPa
Temperature controller	20 – 60 °C	20 – 60 °C	20 – 60 °C	20 – 60 °C
Max. Viscosity	5.000 mPas	5.000 mPas	25.000 mPas	25.000 mPas

	TEMPSPRAY H 326 BASIC UNIT	TEMPSPRAY H 326 SPRAYPACK
Spraying method	-	
Product image (may differ)		
Art. No.	2311661	2311854
Categorie	DPTS	DPTS
Price €	3.065,00	3.635,00
Technology		
Weight	23 kg	-
Drive		
Voltage	230 V / 50 Hz	230 V / 50 Hz
Power connection cable	6 m	6 m
Heater power	1.1 kW	1.1 kW
Recommended max. hose length	30 m	30 m
Max. operating pressure	250 bar, 25 MPa	250 bar, 25 MPa
Temperature controller	20 – 60 °C	20 – 60 °C
Max. Viscosity	25.000 mPas	25.000 mPas

ACCESSORIES – SUPERFINISH

HOPPERS

5 litre hopper, M36x2	0341265
5 litre hopper, with TopClean	0341268
20 litre hopper, M36x2	0341266



20-litre hopper with ball valve

AIRLESS GUNS

Airless gun Vector Pro, 1/4", incl. TradeTip 3 nozzle holder, with 4-finger trigger	0538040
Airless gun Vector Pro, 1/4", incl. TradeTip 3 nozzle holder, with 2-finger trigger	0538041
Airless gun Vector Grip, 1/4", incl. TradeTip 3 nozzle holder, with 2- and 4-finger trigger	0538043
Airless gun Vector Infinity, G-thread 1/4", incl. TradeTip 3 nozzle holder, with 2-finger trigger	0538085
AG 14, G-thread 1/4"; incl. TradeTip 3 nozzle holder	0502081A



Vector Grip guns with adjustable handle size

AIRLESS NOZZLES + NOZZLE HOLDERS

2SpeedTip nozzles	0271XXX
TradeTip 3 FineFinish nozzles	0554XXX
TradeTip 3 nozzles	0553XXX
HEA ProTip nozzles	0554XXX
Nozzle holder, G-thread 7/8", for TradeTip 3 nozzles	0289390
Nozzle extension 15 cm	556074
Nozzle extension 30 cm	556075

Find an overview of all nozzles in our Download Area on www.wagner-group.com



Various airless nozzles for every application

AIRLESS HOSES

HP hose DN4, max. 27 MPa, M16x1.5, 7.5 m	9984510
HP hose DN6, max. 27 MPa, M16x1.5, 15 m	9984507
HP hose DN6, 27 MPa, NPSM 1/4", 15 m	9984574
HP hose DN4, 27 MPa, NPS 1/4", 7.5 m	9984573

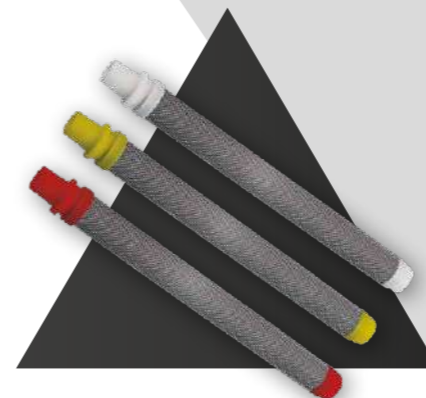

Red, yellow and white plug-in filter - work fast without nozzle blockages

GUN FILTERS

Gun filter red, set 10 pieces, 180 MA, 0.084 mm MW, extra fine	0097022
Gun filter yellow, set 10 pieces, 100 MA, 0.14 mm MW, fine	0097023
Gun filter white, set 10 pieces, 50 MA, 0.31 mm MW, medium	0097024

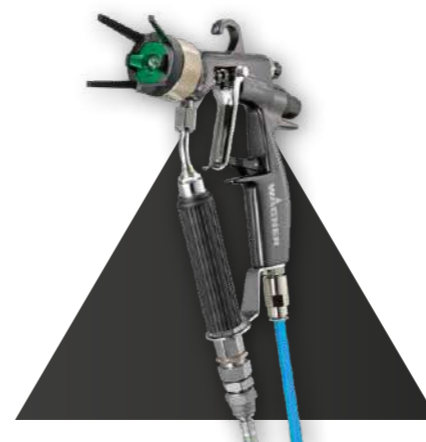

AC 4600 gun - the AirCoat gun for the toughest demands

AIRCOAT GUNS

AC 4500 Professional, incl. blue air cap and nozzle holder	2368269
AC 4500 Professional, incl. red air cap and nozzle holder	2368271
AC 4500 Professional, incl. green air cap and nozzle holder	2368270
Nozzle ACF 3000	379XXX
Nozzle ACF 3000 Plus	321XXX
AC 4600 Professional, incl. blue air cap and holder	394156
AC 4600 Professional, incl. green air cap and holder	394158
AC 4600 Professional, incl. red air cap and holder	394157

AIRCOAT HOSES

Material DN3, max. 27 MPa, air DN6, 1/4", 7.5 m	9984595
Material DN3, max. 27 MPa, air DN6, 1/4", 10 m	9984596
Material DN4, max. 27 MPa, air DN6, 1/4", 7.5 m	2302378
Material DN4, max. 27 MPa, air DN6, 1/4", 10 m	2302379



PumpRunner - for clean and easy transportation of the pump

OTHER ACCESSORIES

SpeedShield	0538905
Large volume containers	2309956
Container Connector, for SF 27/31/33	2371930
PumpRunner (only for Rigid Suction System)	2306987
Hose reel (only for SF33)	2392523
TipClean, container incl. special cleaner; 200ml	2400214
TipClean, refill bottle, 1 liter	2400216
Compressor AirBoost 100	2347935

ACCESSORIES – PROSPRAY

GUN FILTERS

Gun filter yellow, set 10 pieces, 100 MA, 0.14 mm MW, fine	0097022
Gun filter red, set 10 pieces, 180 MA, 0.084 mm MW, extra fine	0097023
Gun filter white, set 10 pieces, 50 MA, 0.31 mm MW, medium	0097024

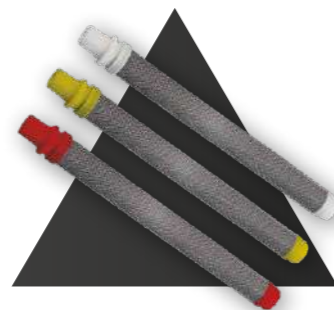

Red, yellow and white plug-in filter - work fast without nozzle blockages

Vector Pro airless gun - easy-pull trigger for comfortable working

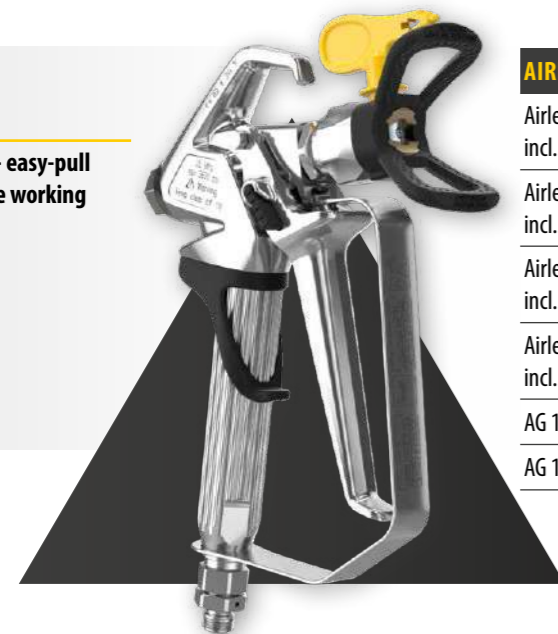

AIRLESS GUNS

Airless gun Vector Pro, G-thread 1/4", incl. TradeTip 3 nozzle holder, with 4-finger trigger	0538040
Airless gun Vector Pro, G-thread 1/4", incl. TradeTip 3 nozzle holder, with 4-finger trigger	0538041
Airless gun Vector Pro, G-thread 1/4", incl. TradeTip 3 nozzle holder, with 4-finger trigger	0538043
Airless Gun Vector Infinity, G-thread 1/4", incl. TradeTip 3 nozzle holder, with 2 finger trigger	0538085
AG 14, G-thread 1/4"; incl. TradeTip 3 nozzle holder	0502081A
AG 19, 25 MPa, G-thread 1/4"; incl. TradeTip 3 nozzle holder	2341127

AIRLESS NOZZLES + NOZZLE HOLDERS

2SpeedTip nozzles	0271XXX
HEA ProTip nozzles	0554XXX
TradeTip 3 FineFinish nozzles	0553XXX
TradeTip 3 nozzles	0554XXX
Nozzle holder, G-thread 7/8", for TradeTip 3 nozzles	0289390

You will find an overview of all nozzles on www.wagner-group.com



Various airless nozzles for every application

POLE GUNS

Pole gun 120 cm, 1/4" nozzle holder, G-thread 7/8"	0296441
Pole gun 200 cm, 1/4" nozzle holder, G-thread 7/8"	0296442

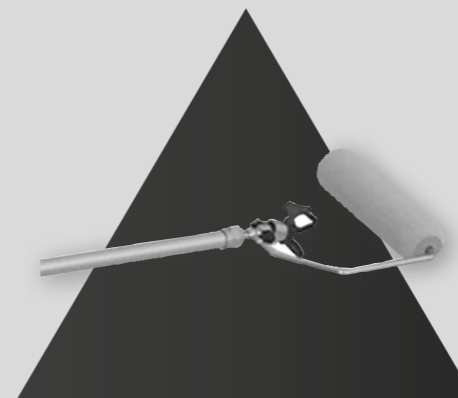

SprayRoller - easily and quickly rolled surfaces



SpeedShield - cutting in without masking

HIGH-PRESSURE HOSES

HP hose DN4, max. 27 MPa, NPS 1/4", 7.5 m	9984573
HP hose DN6, max. 27 MPa, NPSM 1/4", 15 m	9984574
HP hose DN6, max. 27 MPa, NPSM 1/4", 30 m	9984575
HP hose DN6, max. 27 MPa, M16x1.5, 30 m	9984562
HP hose DN10, max. 25 MPa, NPSM 3/8", 15 m	2336583
HP hose DN10, max. 25 MPa, NPSM 3/8", 30 m	2336584

OTHER ACCESSORIES

PumpRunner	2306987
Hopper, 5 litre, for ProSpray 20	704-453
Suction system, flexible, for ProSpray 20	0558672A
InlineRoller in plastic box, incl. HP hose DN4, max. 27 MPa, 7.5 m, extension 0.5 m, woven plush paint roller, short pile 13 mm and much more	0345010
TipClean, container incl. special cleaner; 200ml	2400214
Nozzle extension, 15 cm	556074
Nozzle extension, 30 cm	556075
Nozzle extension, 60 cm	556077
SprayRoller	2411697



ACCESSORIES – HEAVYCOAT

SUCTION SYSTEMS

Container suction system, incl. C-coupling adaptor	0349907
Reduction adaptor B- to C-coupling	9991651
Blanking plug for C coupling	0097305
Container Connector, for HeavyCoat, for direct suction of the material out of the large volume container	2383128
Large volume container, incl. sack support and roller press	2309960



Large-volume container with container connector - for uninterrupted working

GUNS

AG 14, G-thread 1/4", incl. TradeTip 3 nozzle holder	0502081A
AG 19, 25 MPa, G-thread 1/4", incl. TradeTip 3 nozzle holder	2341127
Vector Infinity, G-thread 1/4"; incl. TradeTip 3 nozzle holder, with 2-finger trigger	0538085

Vector Infinity - the lowest holding strength for tireless working



AIRLESS NOZZLES + NOZZLE HOLDERS

2SpeedTip nozzles	0271XXX
TradeTip 3 nozzles	0553XXX
Nozzle holder, G-thread 7/8", for TradeTip 3 nozzles	0289390

You will find an overview of all nozzles on www.wagner-group.com

2SpeedTip nozzles - working and trimming nozzle in one



HP hose DN10

HOSES AND CONNECTORS

HP hose DN10, max. 25 MPa, NPSM 3/8", 15 m	2336583
HP hose DN13, max. 25 MPa, NPSM 1/2", 15 m	2336585
Hose antenna DN10, max. 25 MPa, NPSM 3/8", 2.5 m	2336582
Coupling sleeve I = 1/4"NPSM x A = 3/8"NPSM; 27 MPa	0179732
Double connector A = 1/2" x 3/8" (hose reducer)	3203026
Double connector A = 3/8" x 3/8" (hose connector)	0256343
Double connector A = 1/2" x 1/2" (hose connector)	3202901
Double connector A = 3/4" x 3/4" (hose connector)	9985781



TipClean - easy cleaning and storage of your airless nozzles

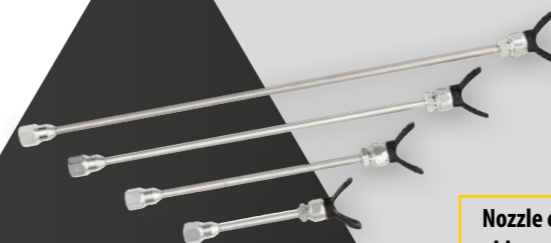

Nozzle extension - for more comfortable working and a wider reach

NOZZLE EXTENSIONS

Nozzle extension, 15 cm, G-thread	0556074
Nozzle extension, 30 cm, G-thread	0556075
Nozzle extension, 45 cm, G-thread	0556076
Nozzle extension, 60 cm, G-thread	0556077

OTHER ACCESSORIES

TipClean, container incl. special cleaner; 200ml	2400214
EasyGlide, special oil, 118 ml	508619



ACCESSORIES – PLASTCOAT



Continuous mixer for dry materials

ACCESSORIES FOR FLOW MIXER PLASTMIX 15

Flow meter	2349234
Mixing shaft	2349436
PUR mixing tube	2359241
Power cable, 6 m	2349166
Transport shaft	2349434

ACCESSORIES FOR PLASTCOAT HP 10

Spray lance (without nozzle holder and nozzle)	2368604
TradeTip 3 nozzle 639	0553639
TradeTip 3 nozzle 643	0553643
Nozzle holder, G-thread 7/8", for TradeTip 3 nozzles	0289390
Mortar hose (DN 19; 10 m)	2368630
Mobility hose (DN 13; 2.5 m)	2368631
Extension hose (DN 19, 10m)	2368627
Extension hose (DN 19, 20m)	2368628
Extension hose (DN 19, 30m)	2368629
Remote operation	2368460
Extension cable for remote operation in different lengths (5 - 40 m)	23685XX
Rotor and stator; complete	2367496
PlastCoat HP10 sack press table	2367229
Cleaning ball	2368524
Cleaning and conservation agent (1 l)	2368525

AG 19 gun - the perfect gun for working with fillers



PlastGuard longlasting - to protect the device and for optimum storage



ACCESSORIES FOR PLASTCOAT HP 30

HP hose DN19, 10m	2390763
HP whip hose, DN10, 2.5m	2390762
HP hose DN10; max. 25 MPa; NPSM 3/8"; 15 m	2336583
Airless gun AG 19; 25 MPa; G-thread 3/8"; incl. TradeTip 3 nozzle holder	2341127
Airless gun Vector Pro; 1/4"; incl. TradeTip 3 nozzle holder; with 4-finger trigger	538040
TradeTip 3 nozzles	0553XXX
HEA ProTip nozzles	0554XXX
Nozzle holder; G-thread 7/8"; for TradeTip 3 nozzles	0289390
Nozzle extension, 30 cm, G-thread, with holder without nozzle	556075
Nozzle extension, 60 cm, G-thread, with holder without nozzle	556077
Rotor and stator; complete; for PlastCoat HP 30	2395996
Cover for material hopper	2400030
Press table	2389048
PlastGuard pump protector	2399959
PlastGuard longlasting pump protector	2399960
PlastCoat HP 30 emulsion set	2400684

Cleaning balls - for cleaning out hoses and avoiding nozzle blockages

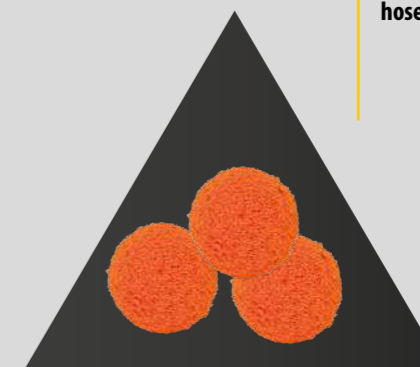

CLEANING AND STORAGE

Brush with handle and cap	9100095
Bottle brush for cleaning interior of outlet unit and spraying lance	0342329
Cleaning adapter M27GK	0342241
Cleaning brush, 280 to 420 mm long	0348959
Cleaning ball DN16	2402355
Cleaning ball DN19	342330

SUPPORT TABLE INCL. ROLLER PRESS

Support table cpl. for PC 830	2318389
Support table cpl. for PC HP 30	2389048



Bag squeezing table - for the convenient processing of bagged goods



ACCESSORIES – LIGHT DEVICES

XVLP FINISHCONTROL SPRAY ATTACHMENT

FineSpray spray attachment	2321877
StandardSpray spray attachment	2321879
WallSpray spray attachment	2321880



FineSpray spray attachment XVLP - for glazes and lacquers

HVLP GUNS

Gravity feed cup, for FineCoat Split Gun, 600 ml	0524053
FineCoat Split Gun; suction cup; 1000 ml	0524028
Conversion kit FineCoat Split Gun, for gravity feed cup	0524045

HVLP Split gun - 600 ml flow cup - for wood & metal paints

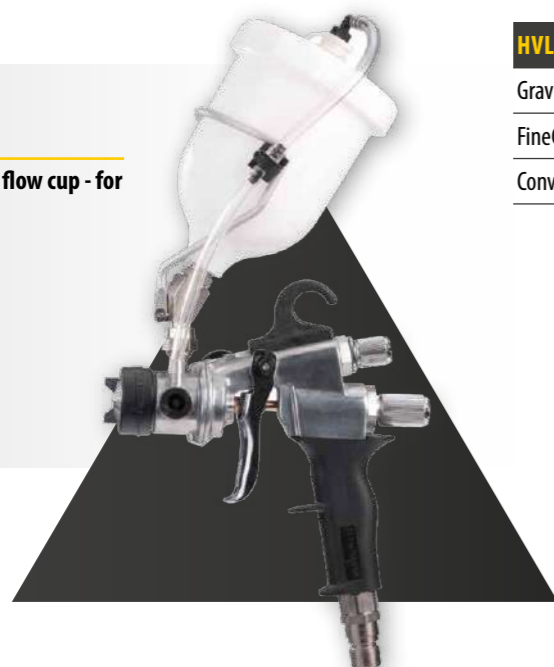

AIR HOSE

Air hose including handle, for FinishControl 5000	2314573
Air hose assy. FC-9900 Plus	0277236
Air hose, 4.5 m, for FineCoat turbines incl. quick release coupling	0276233
Hose pack, consisting of material and air hose DN10, 8.2 m	0261255
Hose whip, 152 cm, for FineCoat	0524405

Nozzle set - for different materials

NOZZLE SET FOR FINECOAT SPLIT GUN

Nozzle set, for FineCoat Split Gun, no. 2, Ø 0.8 mm	0529209
Nozzle set, for FineCoat Split Gun, no. 3, Ø 1.3 mm	0529210
Nozzle set, for FineCoat Split Gun, no. 4, Ø 1.8 mm	0529211
Nozzle set, for FineCoat Split Gun, no. 5, Ø 2.2 mm	0529212
Nozzle set, for FineCoat Split Gun, no. 6, Ø 2.4 mm	0529213
Nozzle set, for FineCoat Split Gun, no. 7, Ø 2.6 mm	0529214

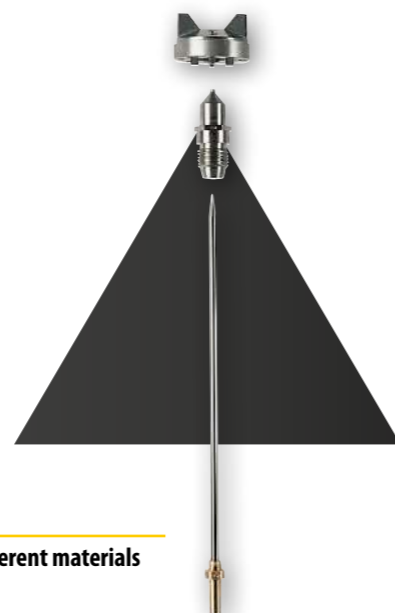

CONTROL PRO ACCESSORIES

HEA Tip, different sizes (e.g. tip 211 - Art.No. 517211)	517XXX
Red, extra fine, 1 pc. (for HEA 211/311/313/413 nozzles)	34383
Yellow, fine, 1 pc. (for HEA 515 nozzle)	43235
White, medium, 1 pc. (for HEA 517/619 nozzles)	34377
ControlPro nozzle extension, 30 cm, G-thread	517700
ControlPro nozzle extension, 60 cm, G-thread	517701
EasyGlide (118 ml)	508619

HEA-Tip Control Pro



BE UNSTOPPABLE!



NOTES

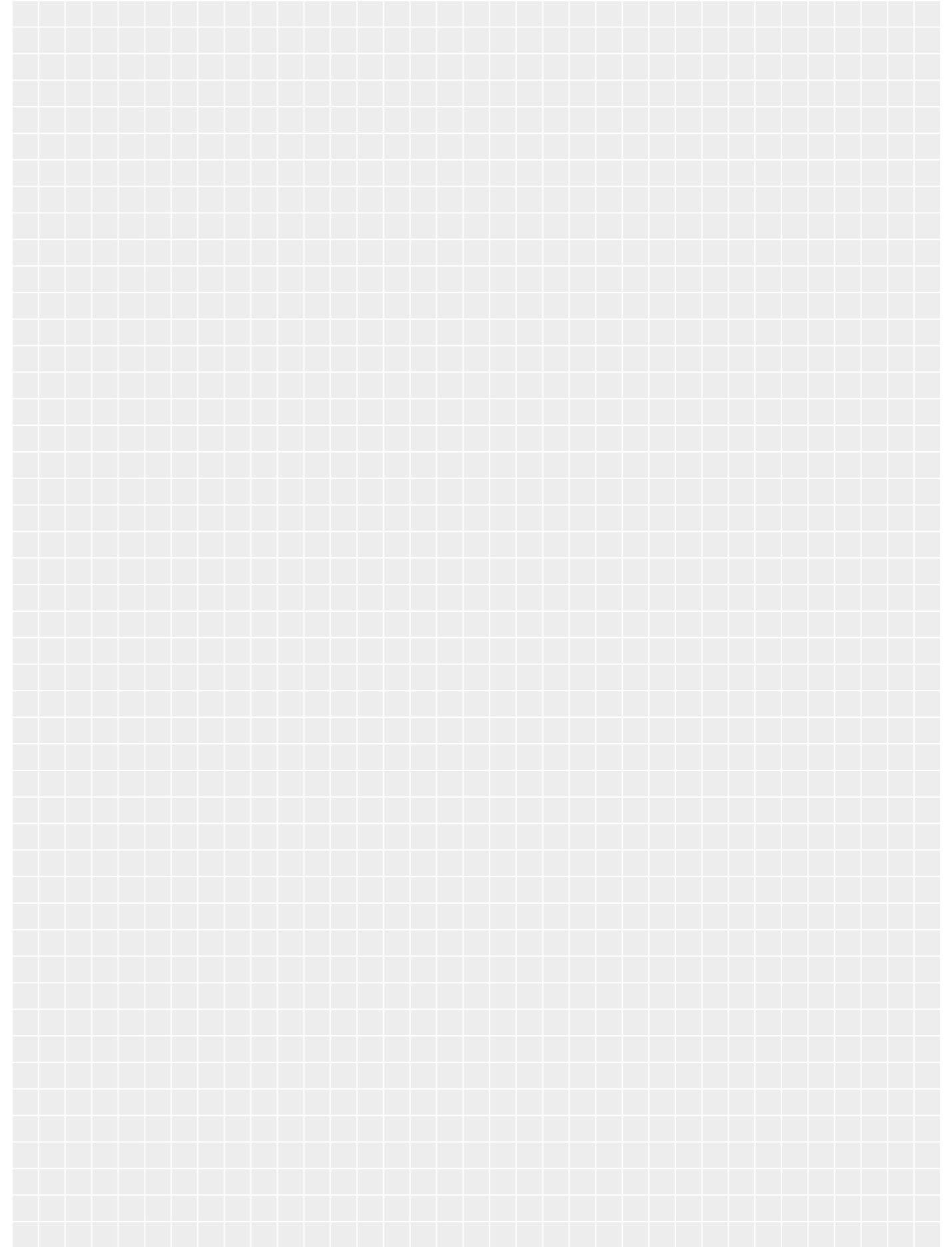

NOTES

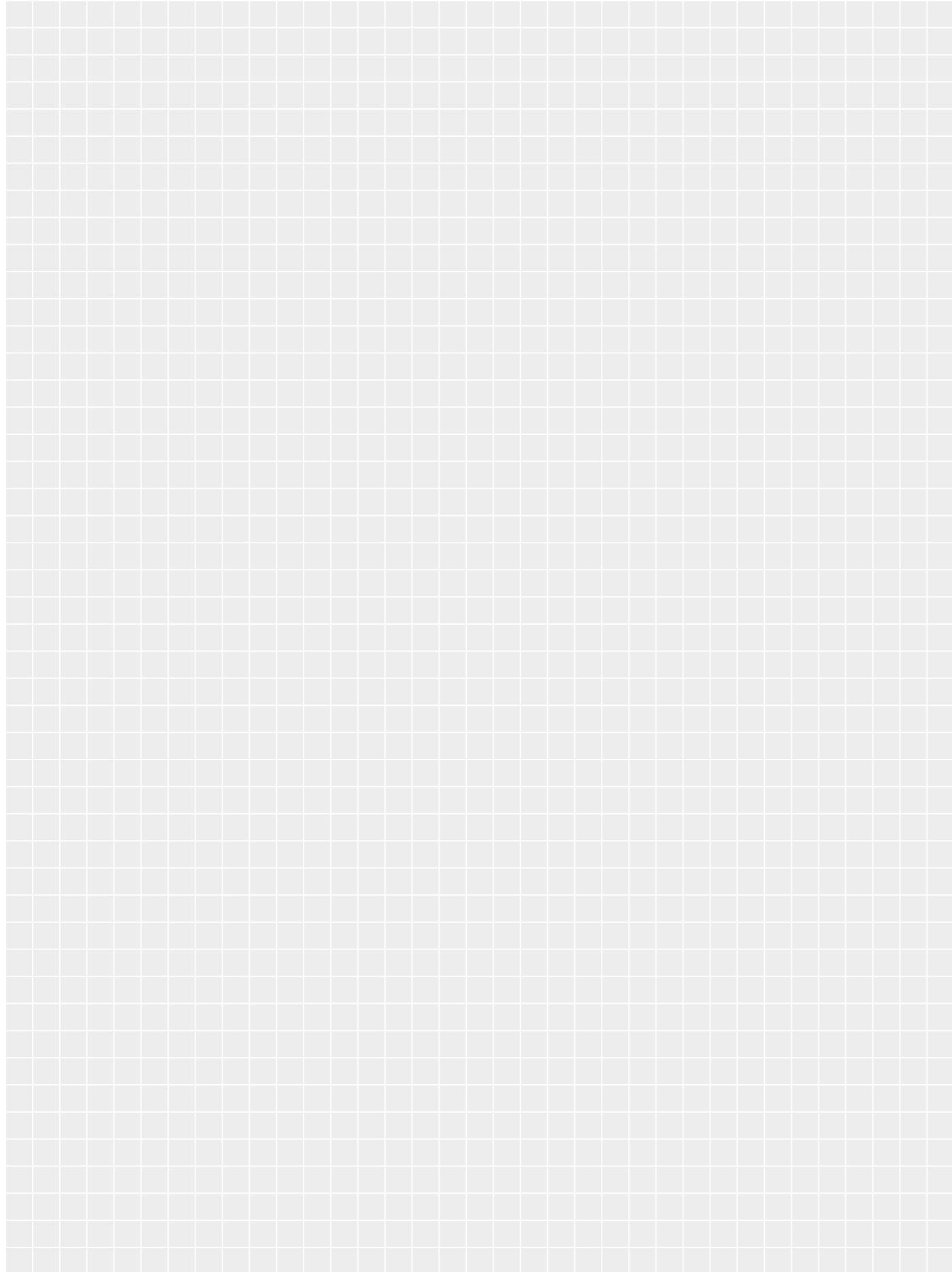

NOTES

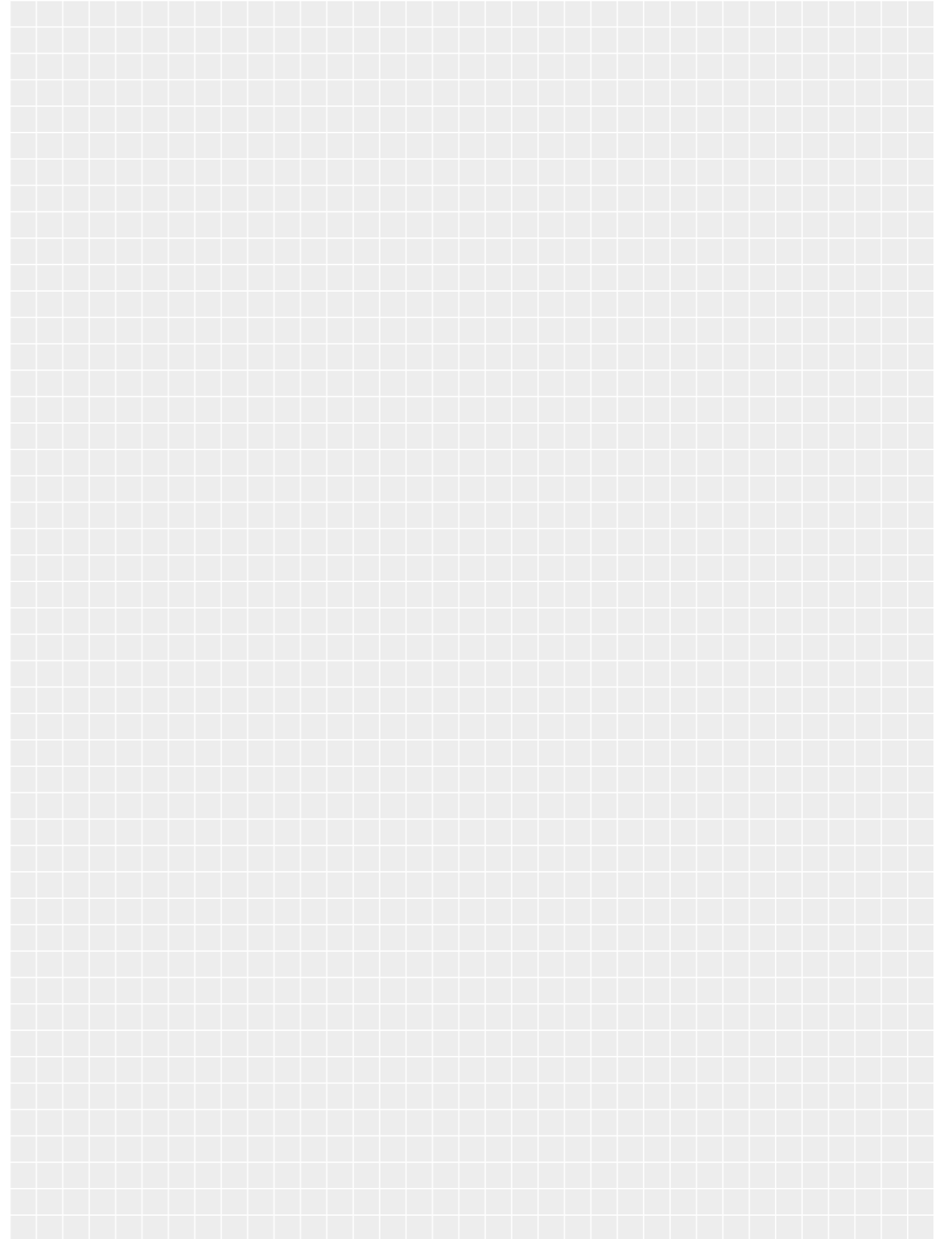

BE UNSTOPPABLE!

VISIT US AT

